

ROOM DIVIDERS

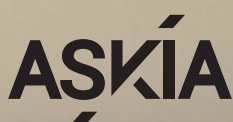

Rectangular Room Dividers	4
Irregular Room Dividers	12
Interactive Room Divider	18
Cables Kit	22
Color Swatches	24
Sustainability & Efficiency	28



RECTANGULAR ROOM DIVIDERS

With a wide variety of styles and aesthetics, as well as three installation methods, the acoustic panels ensure a perfect fit in any room.

The Rectangular Room Divider Collection, crafted from PET-Felt, greatly diminishes background noise, enhancing acoustic performance.

Features and benefits

- All panels are made from PET-Felt, known for its excellent acoustic properties.
- The rectangular room dividers provide three easy installation process.
- The collection features a wide range of creative designs

Applications

- Due to the wide variety of designs, the room dividers are well-suited for any interior.
- The panels are highly practical for organizing space.



MAZE

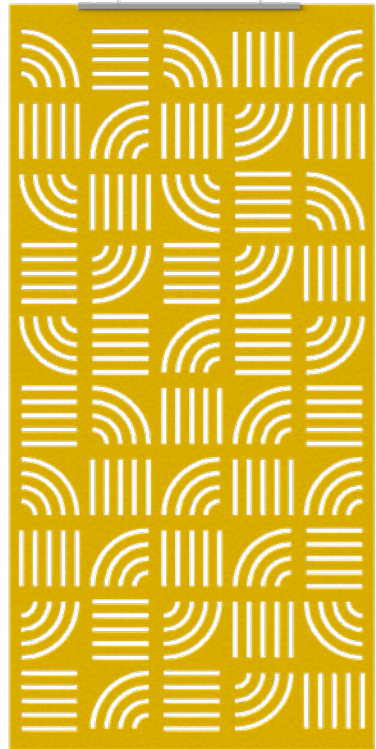

The combination of arcs and straight lines in the Maze panel pattern evokes the intricate and challenging path of a labyrinth.

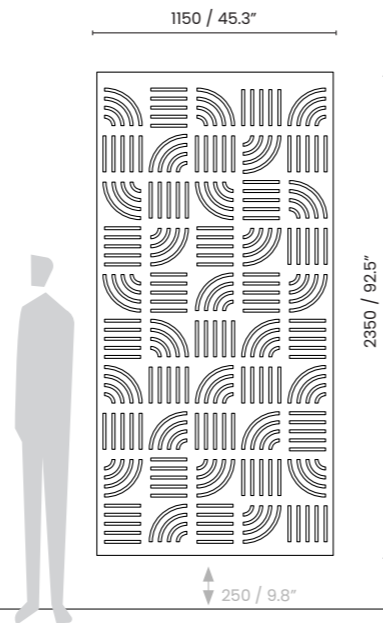

WAVE



The Wave panel features a unique design highlighted by its playful pattern of cut arcs. As a result, the space where it's installed gains a vibrant and joyful ambiance.

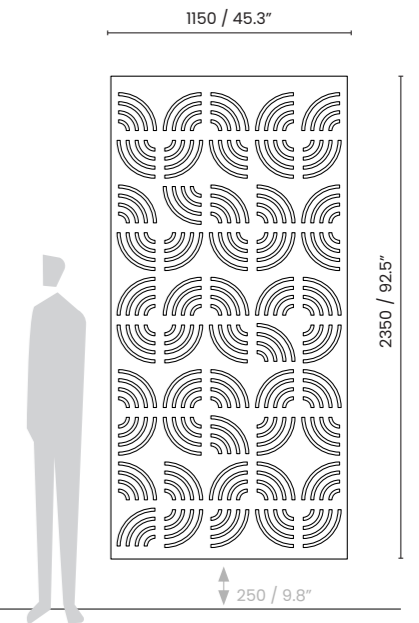

TWIST

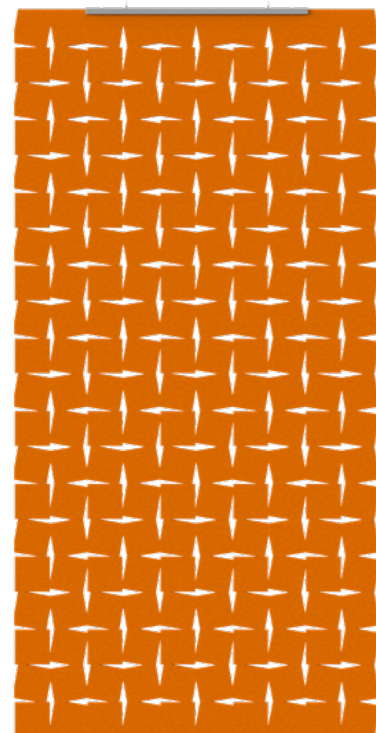

The arrangement of Twist acoustic panels creates a seamless pattern of rotated squares, adding a dynamic and visually engaging element to any space.

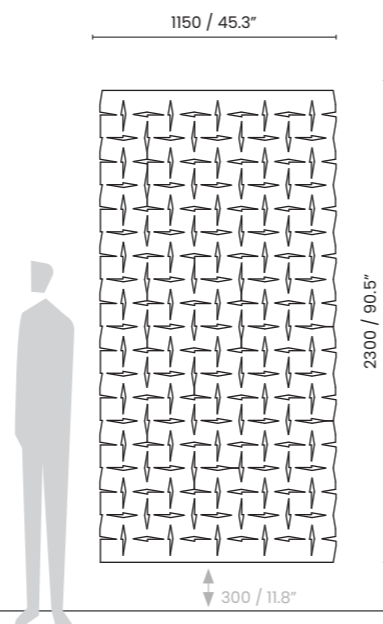

RAIN

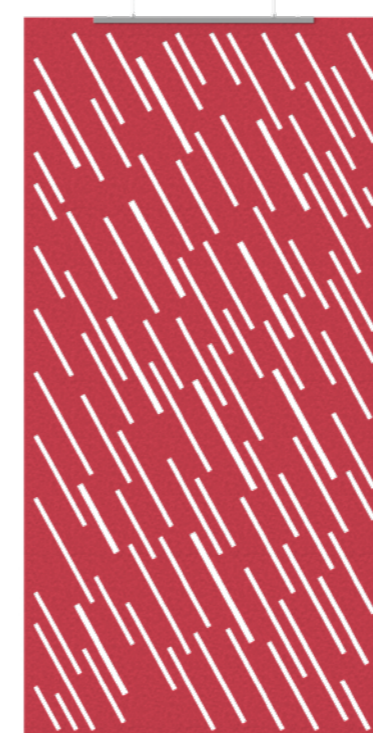

The Rain room divider brings a natural character to any space through its aesthetic theme inspired by water.

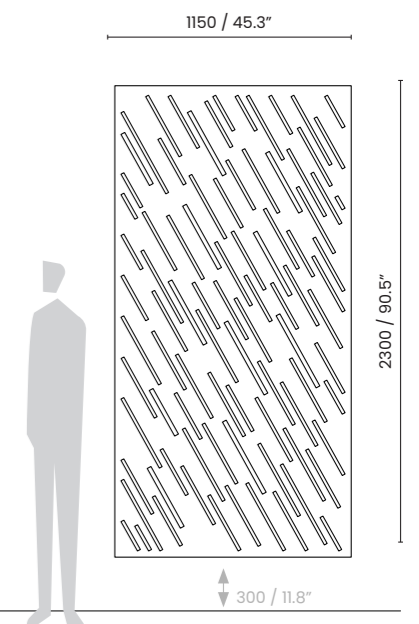



RELIEF



Relief is the perfect solution for those looking to blend organic aesthetics with linear design. The model draws inspiration from topographic maps, incorporating stylized elements extracted from them.

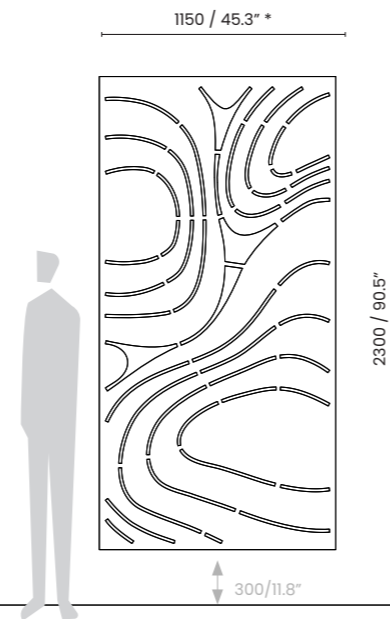

DROPS



The graphic design of the Drops room divider mimics raindrops, creating a playful and vibrant pattern that energizes the space it inhabits.

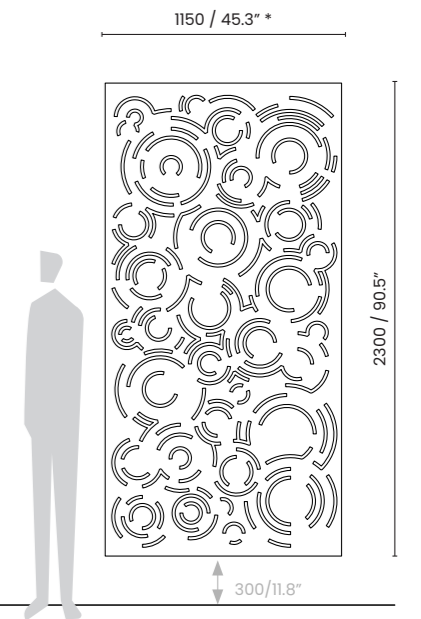

ROOT



The Roots acoustic panel stands out with its stylized depiction of tree bark texture. This creates a visually appealing and organic pattern.

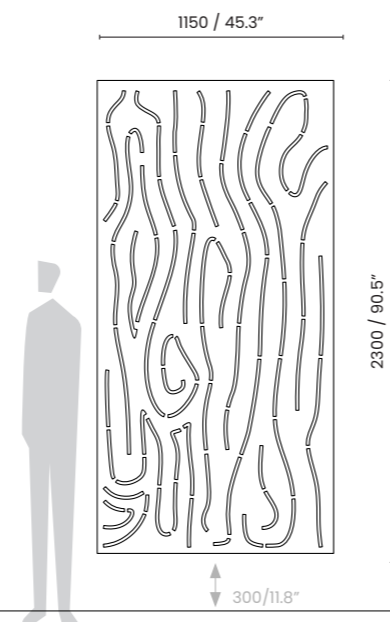

SEA

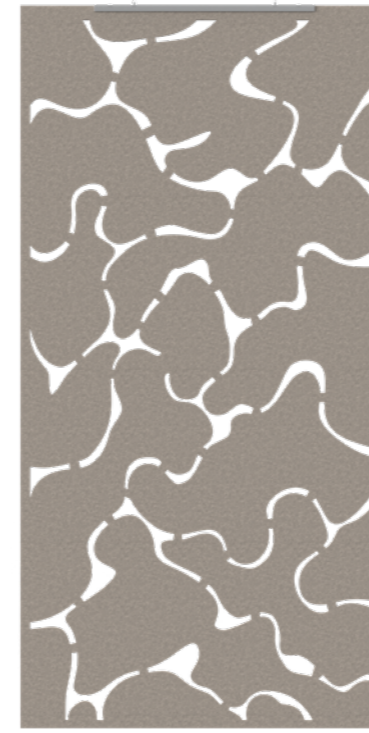

The stylization of the sea's gentle waves, captured in the Sea acoustic panel, gives it an exceptionally pleasing visual appeal.

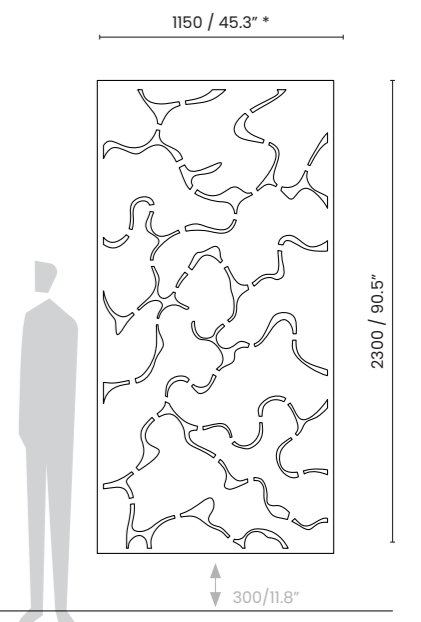



CRICKET

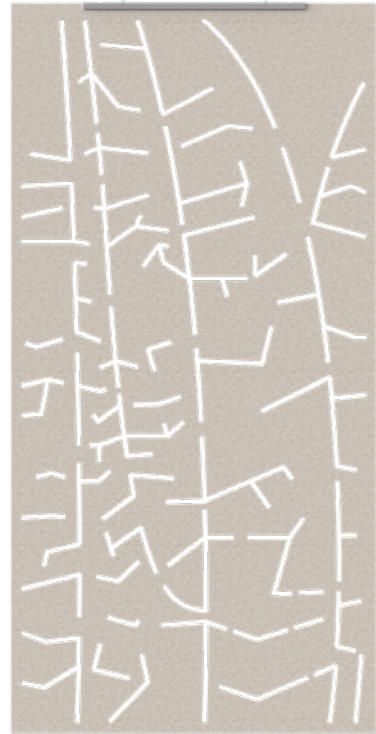

The perforated segments of the Cricket divider create a dynamic panel that, as its name suggests, captures the detail of a cricket's wing.



DRAGONFLY



As its name implies, the Dragonfly divider showcases perforated segments that create an elegant panel, reflecting the intricate details of a dragonfly's wing.

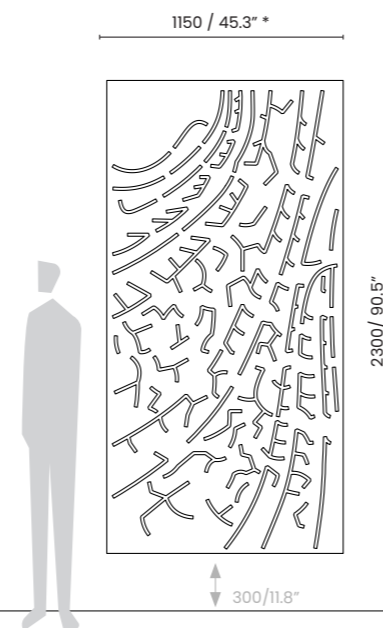



IRREGULAR ROOM DIVIDERS

The panel's organic shapes and forms bring a touch of elegance and a unique flair to any space. With two installation options, they help improve space organization and adapt easily to different needs.

Made from PET-Felt, the Irregular Room Divider Collection also significantly reduces background noise, improving acoustics.

Features and benefits

- All panels are made from PET-Felt, known for its excellent acoustic properties.
- The irregular room dividers provide three easy installation processes.
- The collection features a wide range of creative designs

Applications

- Due to the wide variety of designs, the room dividers are well-suited for any interior.
- The panels are highly practical for organizing space.



FLUX

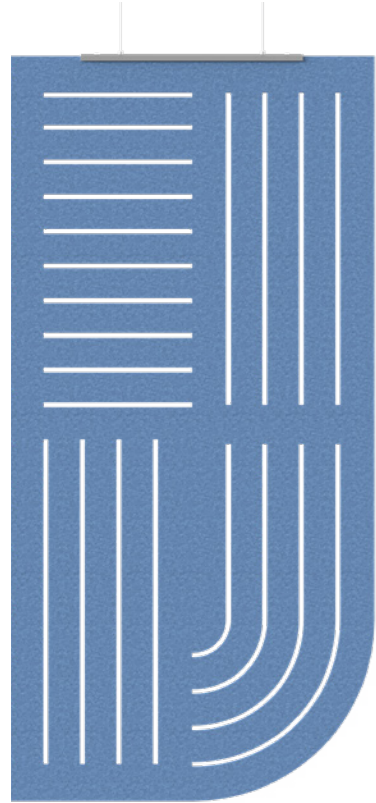

Flux is a standout room divider with a clean, simple pattern that perfectly captures the spirit of its name.

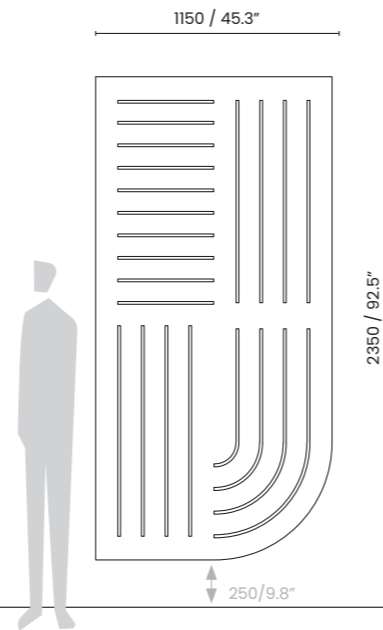

MAGMA



Magma is one of three acoustic panels designed with inspiration from the elaborate texture of volcanic rocks.

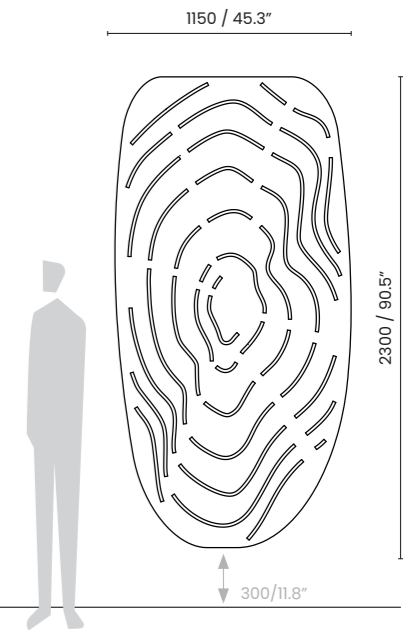

POLAR



The Polar acoustic solution offers a playful take on the concept of "polar opposites." This idea is reflected in a simple yet evocative design that integrates easily into various spaces.

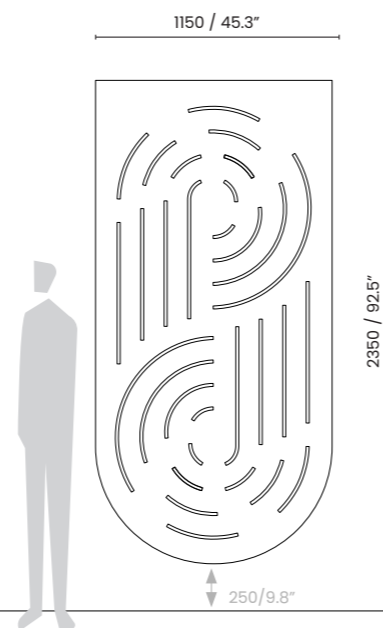

METEOR



Inspired by the natural lines of rocks, the Meteor panel provides an organic aesthetic to any environment in which it is placed.

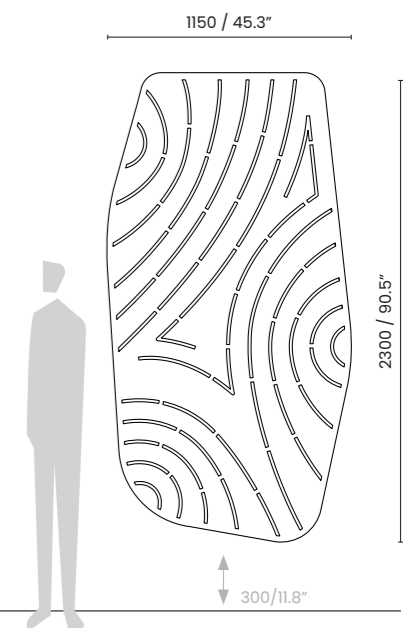



ROKA



Featuring a stylized pattern inspired by volcanic rocks, the Roka acoustic panel offers a refined solution for organizing interior spaces.

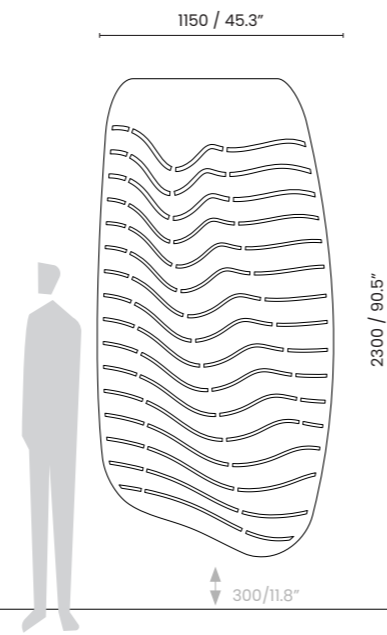



INTERACTIVE ROOM DIVIDER

This panel's sound quality gets a boost from its interactive feature, letting you customize it by moving the attached elastic to create your own unique patterns.

The Interactive Room Divider Collection, made from PET-Felt, enhances overall acoustics by reducing background noise.

Features and benefits

- All panels are made from PET-Felt, known for its excellent acoustic properties.
- The rectangular room dividers provide three easy installation processes.
- The panel is designed to be customized by adjusting the arrangement of the attached rope.
- The attached cord serves a practical purpose, acting as an excellent support for various items that can be hung or held by it, such as books, magazines, notes etc.

Applications

- Thanks to its customizable design, the panel can be integrated into a variety of interior spaces.
- The panels are highly practical for organizing space.



WEB

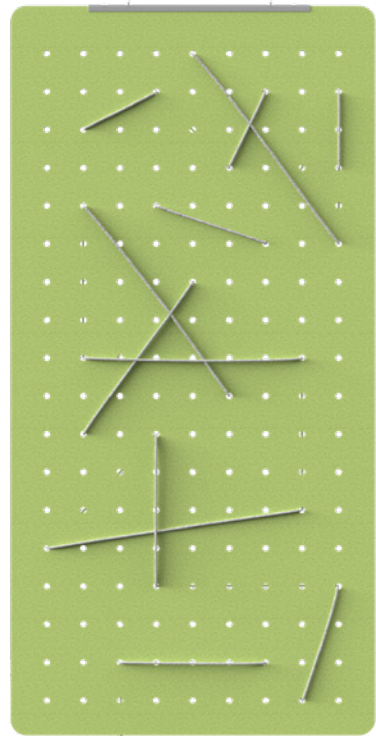

The panel's acoustic performance is enhanced by its interactive feature, which allows for custom patterns using the adjustable cord.

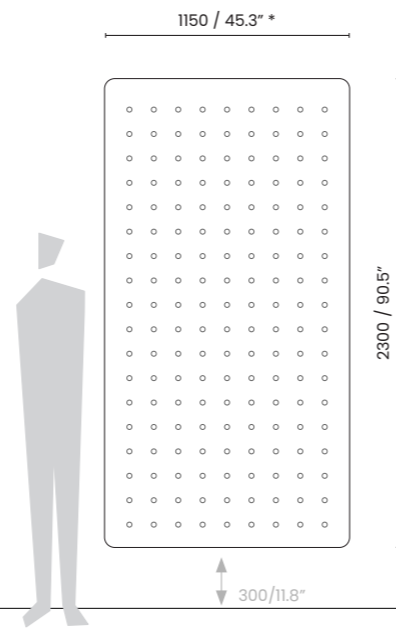

Rope Color

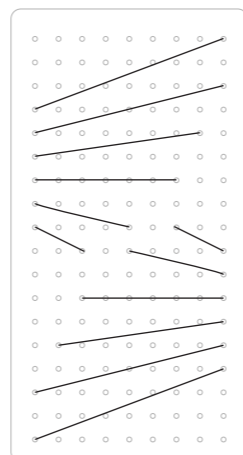
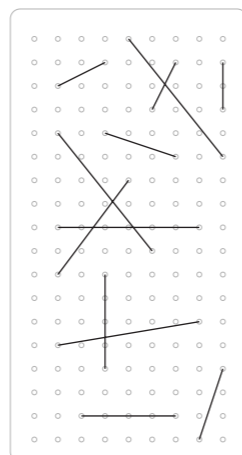
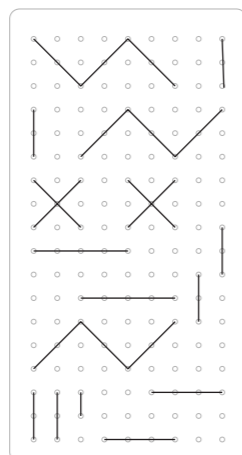
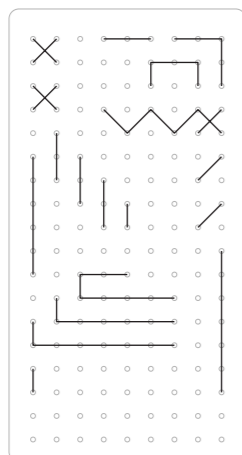
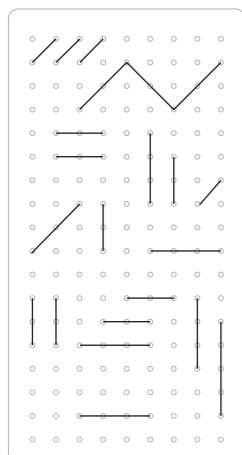

CABLES KIT

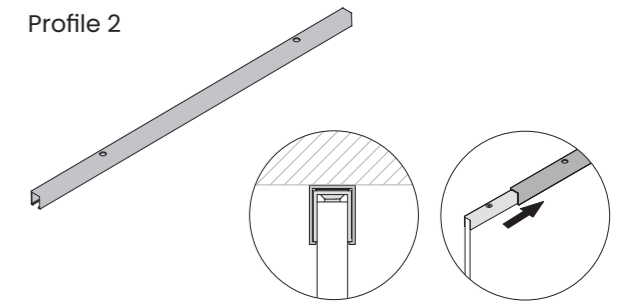
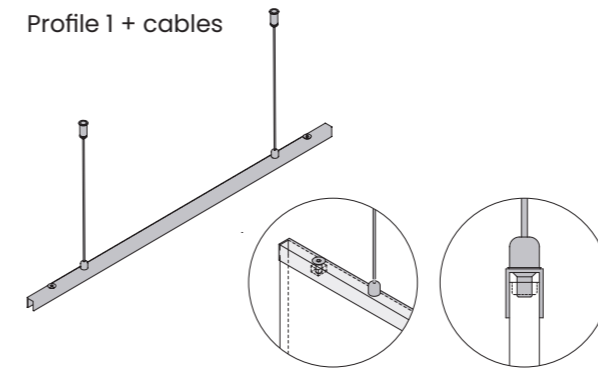

RECTANGULAR ROOM DIVIDERS

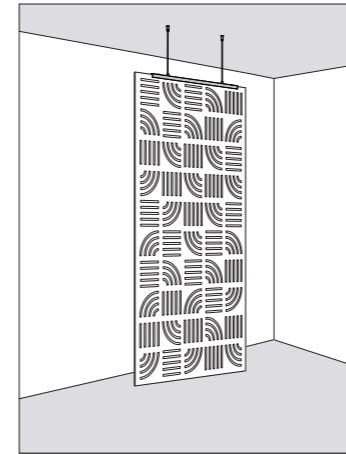

Ceiling Suspended

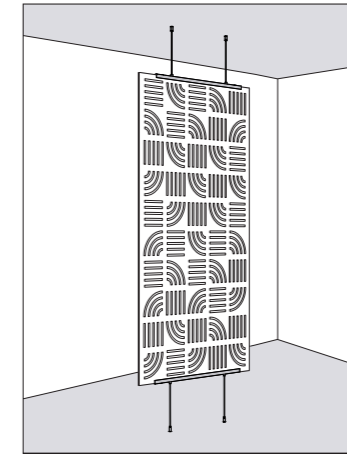

Ceiling and Floor
Suspended

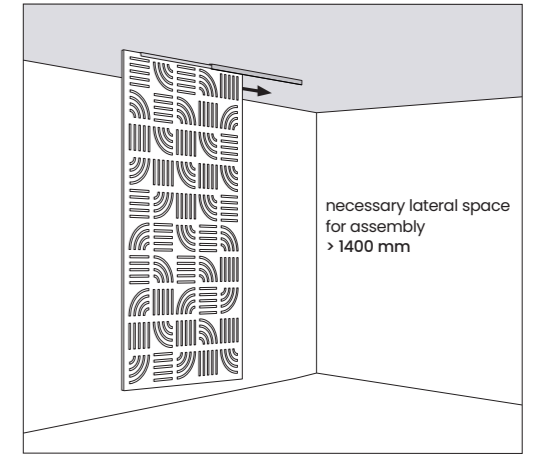

Ceiling Mounted

IRREGULAR ROOM DIVIDERS

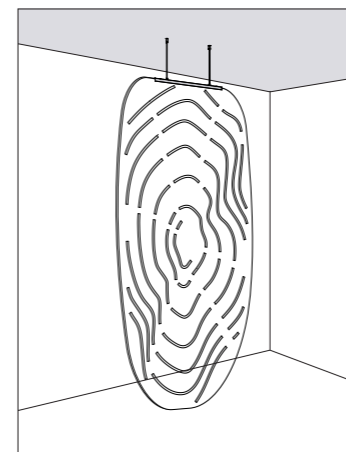

Ceiling Suspended

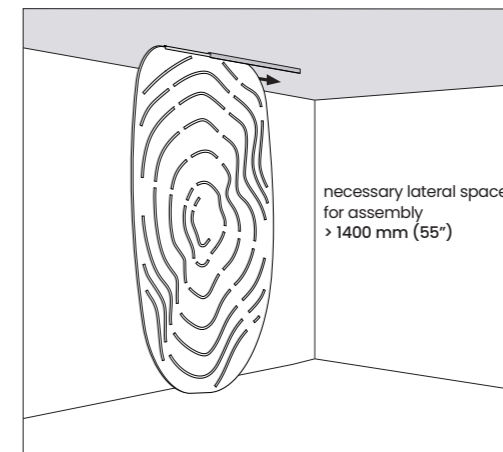

Ceiling Mounted

COLOR SWATCHES

We provide a broad range of color choices for PET-Felt, allowing these products to easily complement a wide variety of interior spaces.

With a vast selection of hues available, you can easily match or contrast with existing decor, making it simple to achieve the perfect look and feel for any environment.

PET-FELT

Weight	Material	Thickness	Applications
2400 g/mp	PET-Felt	12 mm	Indoor areas only

Color

Slight color deviations may occur since the PET Felt panels are made from recycled fibers. It is recommended to use the same batch per project. When placing an order take a margin into account for unforeseen changes or additions to a design plan.

STANDARD



NON-STANDARD



Fire Rating

B-s1, d0 classification
ASTME84 Class A

Environment

ASKIA PET is 50% recycled
ASKIA PET is 100% recyclable

DATASHEET PET-FELT BOARD 12 MM

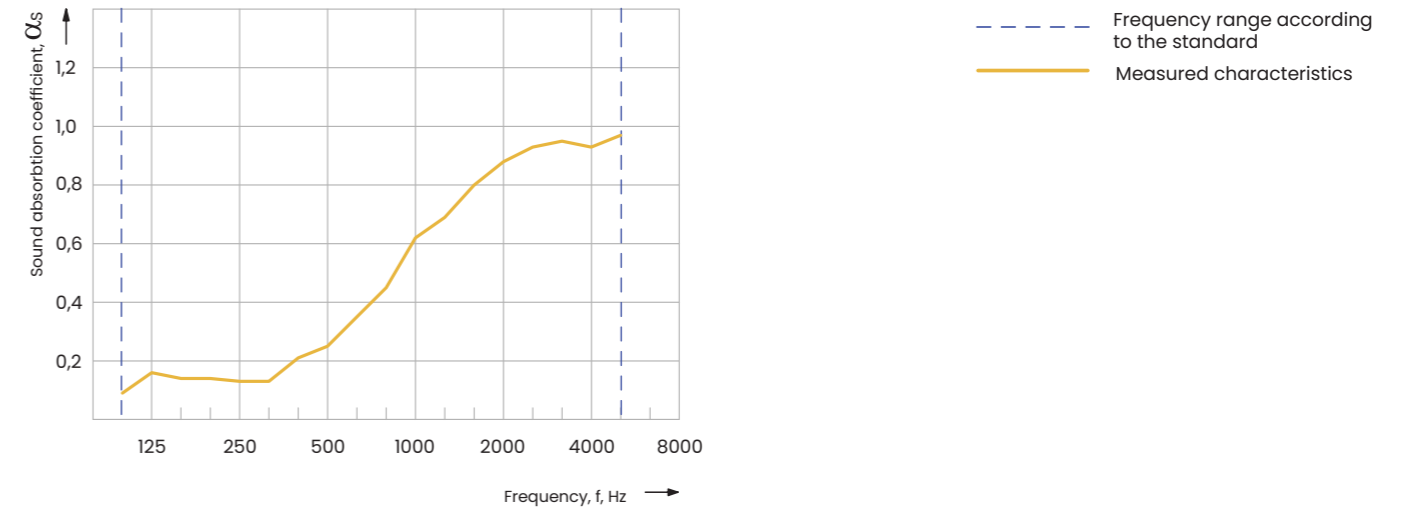

SUSTAINABILITY & EFFICIENCY

We remain humble in front of nature.

Our acoustic panels are carefully crafted from PET-Felt, a sustainable material composed of 50% recycled content and fully recyclable. This choice reflects a commitment to environmental responsibility, supporting a circular economy by reducing waste and conserving resources.

Acoustic panels are designed to enhance absorption, attenuation and diffusion within an interior space. By optimizing how sound waves interact with the surfaces, they improve acoustic quality and create a more pleasant auditory environment. This ensures that sound is distributed evenly and effectively throughout the room, reducing echo and enhancing clarity.



Absorption



Attenuation



Diffusion

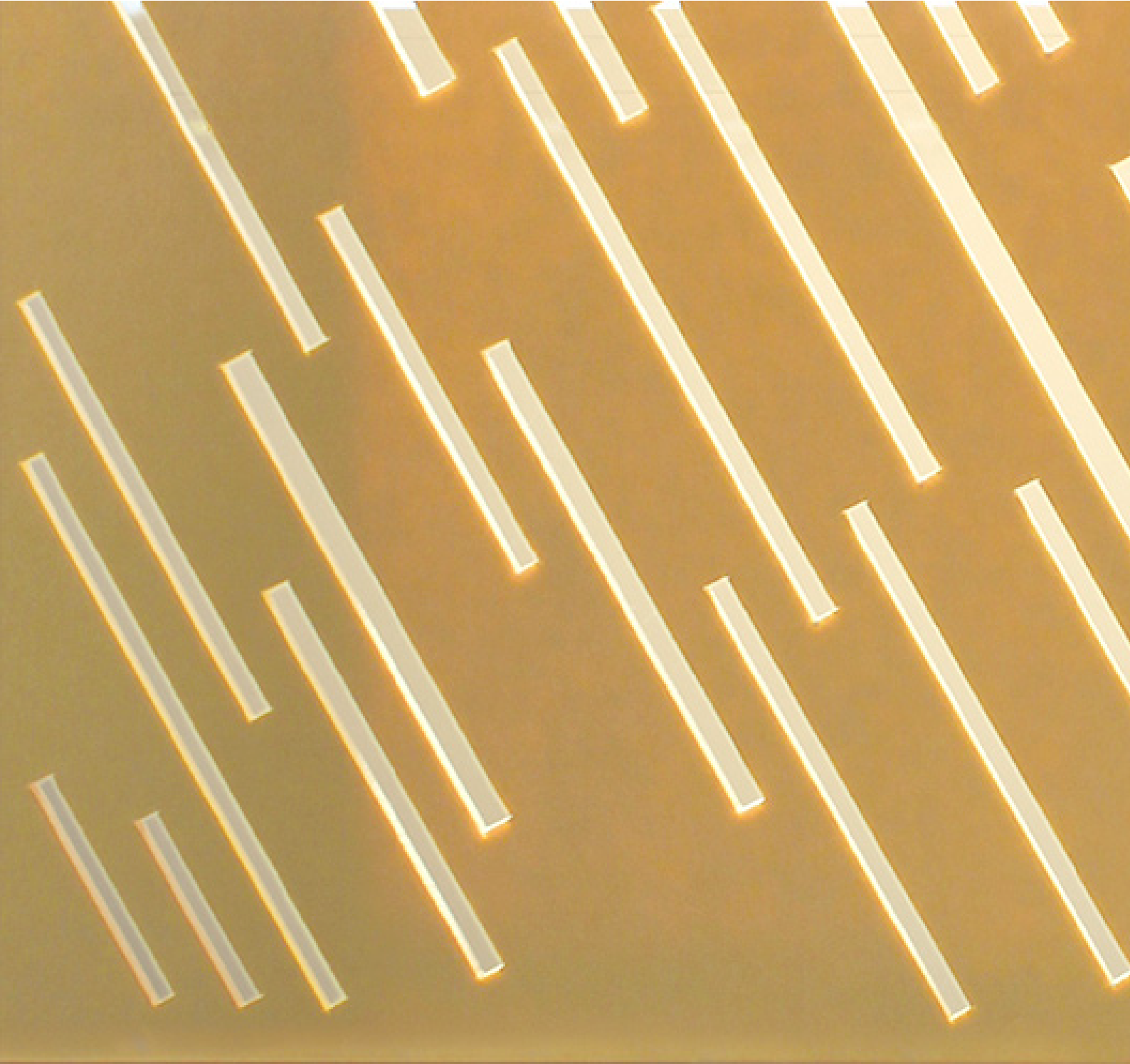

ASKIA