



ASKIA | 2022 CONNECT CATALOGUE



In these ever evolving times, workspaces are changing frequently, adapting to one's needs and values.

The **CONNECT** screen collection offers a wide range of solutions for room and desk partitioning. Just connect the panels and you can create your own work environment, private meeting room or just separate the workspace. With three levels of sound absorbancy capabilities available, these panels offer more than just visual separation from the work environment. They also increase acoustic comfort, helping you focus better on your work.

With vast knowledge and great attention to detail, ARS (AŞKIA Research Studio) develops home and office furniture that improves spaces.

ACOUSTIC PROPERTIES SYMBOLS



Attenuation

Materials that reflect sound with less energy, reducing the amplitude of the sound bounced back, reducing echoes in a room.



Diffusion

A surface or material that has irregularities and reflects sound in multiple trajectories, reducing sound's focalized target.



Absorption

The ability of a material to dissipate sound inside of its internal structure and absorb the sound. Materials with porous and fibrous natures present excellent sound absorption properties.

FLOOR SCREENS

MOBILE SCREENS

pg. 3

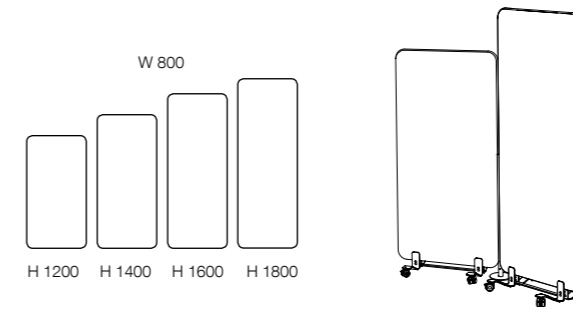

FIX SCREENS

pg. 7

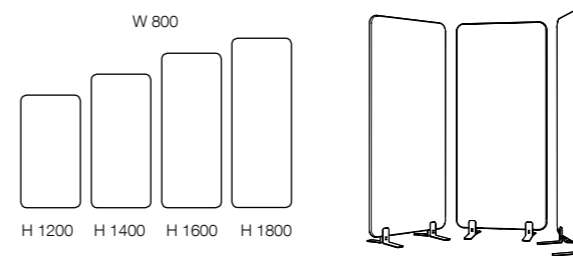

FLOOR SCREEN COMPOSITION & ACOUSTIC PROPERTIES

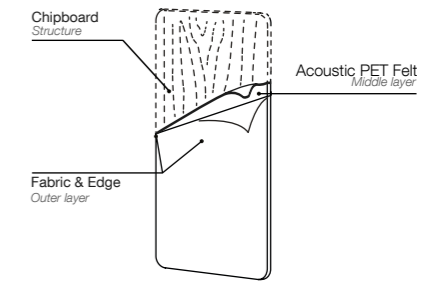

Attenuation

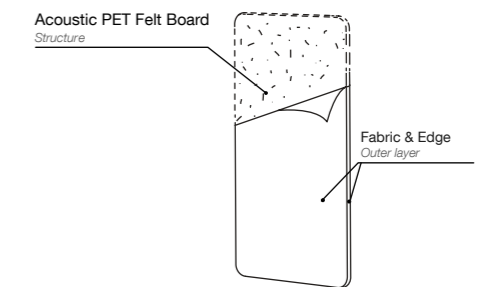

Attenuation | Absorption

TABLE SCREENS

FRONT SCREEN

pg. 10

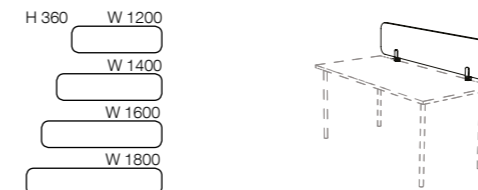

MODESTY SCREEN

pg. 12

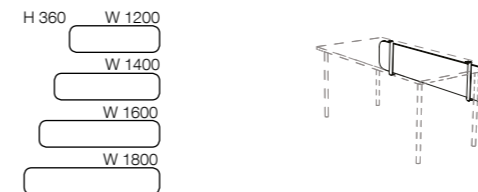

SIDE SCREEN

pg. 14

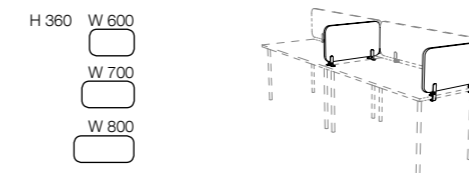

WORKBENCH SCREEN

pg. 16

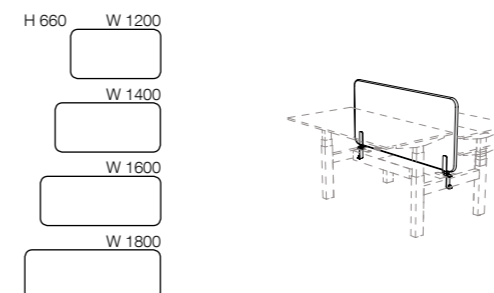
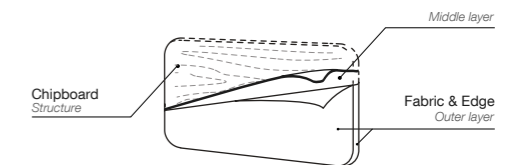
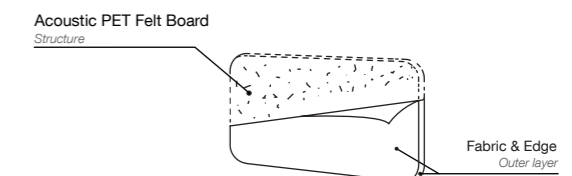

TABLE SCREENS COMPOSITION & ACOUSTIC PROPERTIES



Attenuation



Attenuation | Absorption

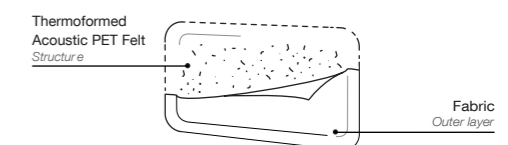

Attenuation | Absorption



Attenuation



Absorption

Set up your space exactly the way you want it.

The **CONNECT FLEXI** collection comes in 4 height options, with 2 types of bases and numerous customization possibilities. The best feature of these screens consists in the magnetic connection system. With the help of a vertical connector and magnets embedded in the screens, they can be attached, leading to various angles and configurations for your space.

The screens can be equipped with a **2 in 1 Pinboard and Whiteboard** panel or with a clothes **hanger**.

FLEXI SCREEN
by ARS



ATELIER LOUNGE
by Dragos Motica

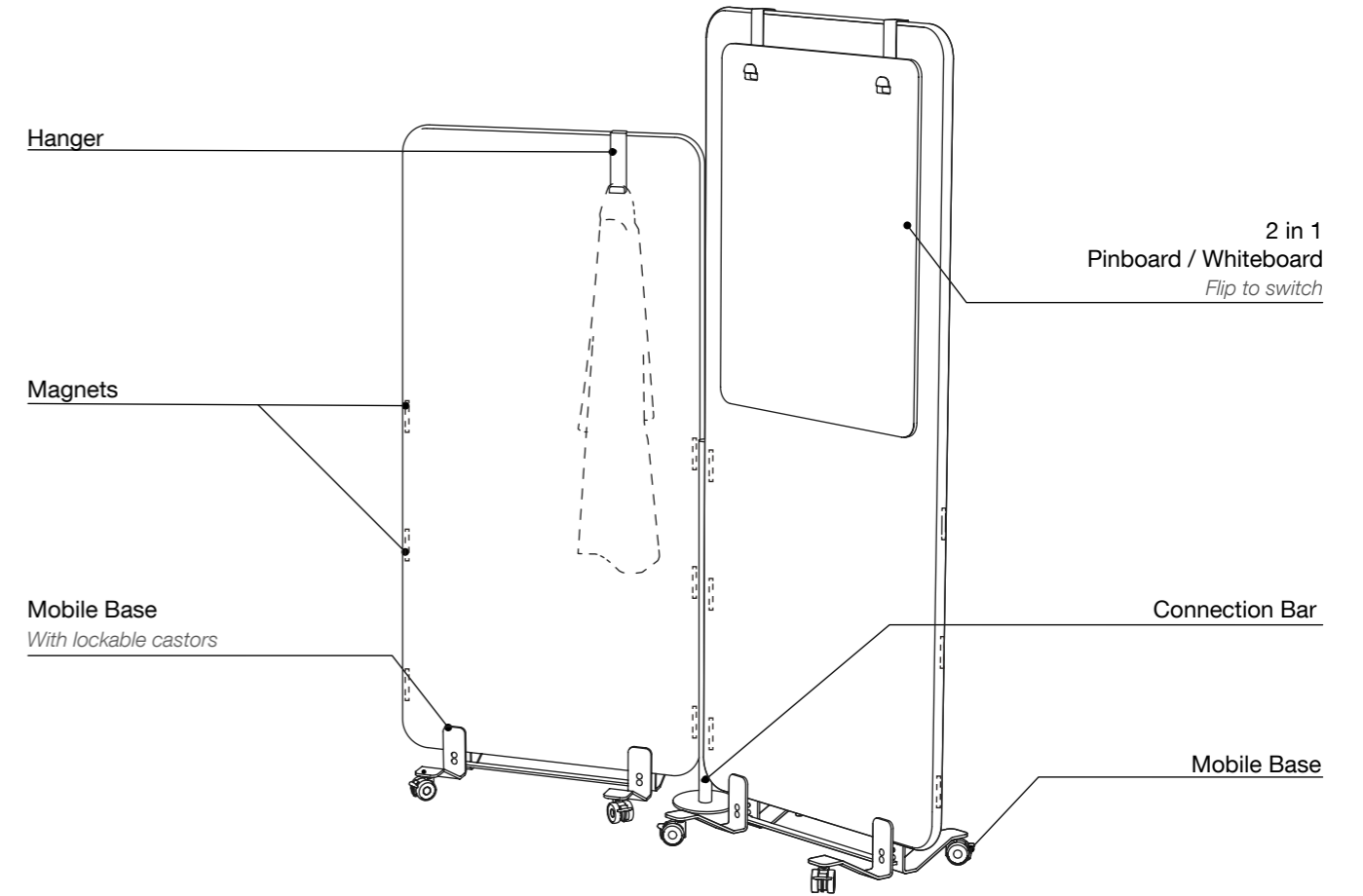

TECHNICAL DETAILS

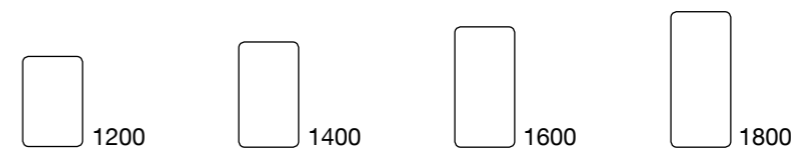

BASE TYPES

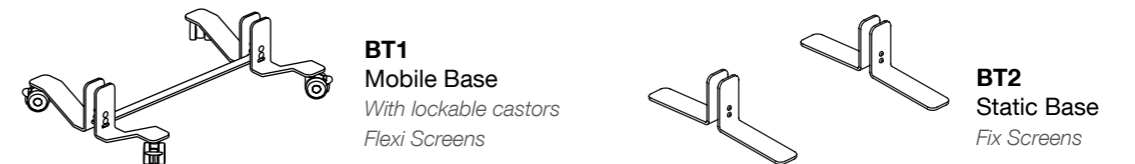

ACCESORIES

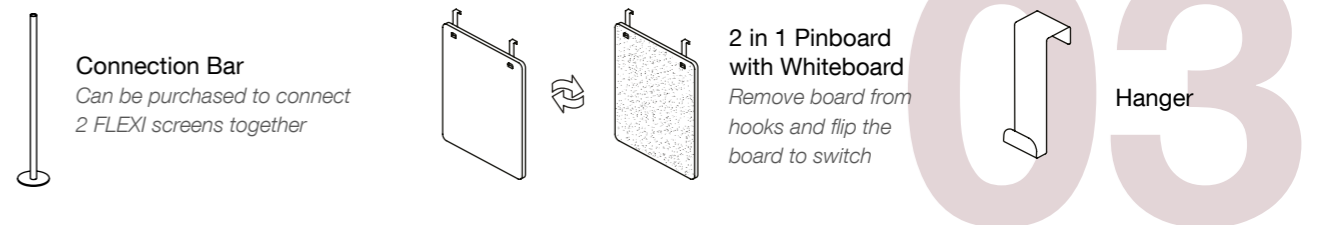

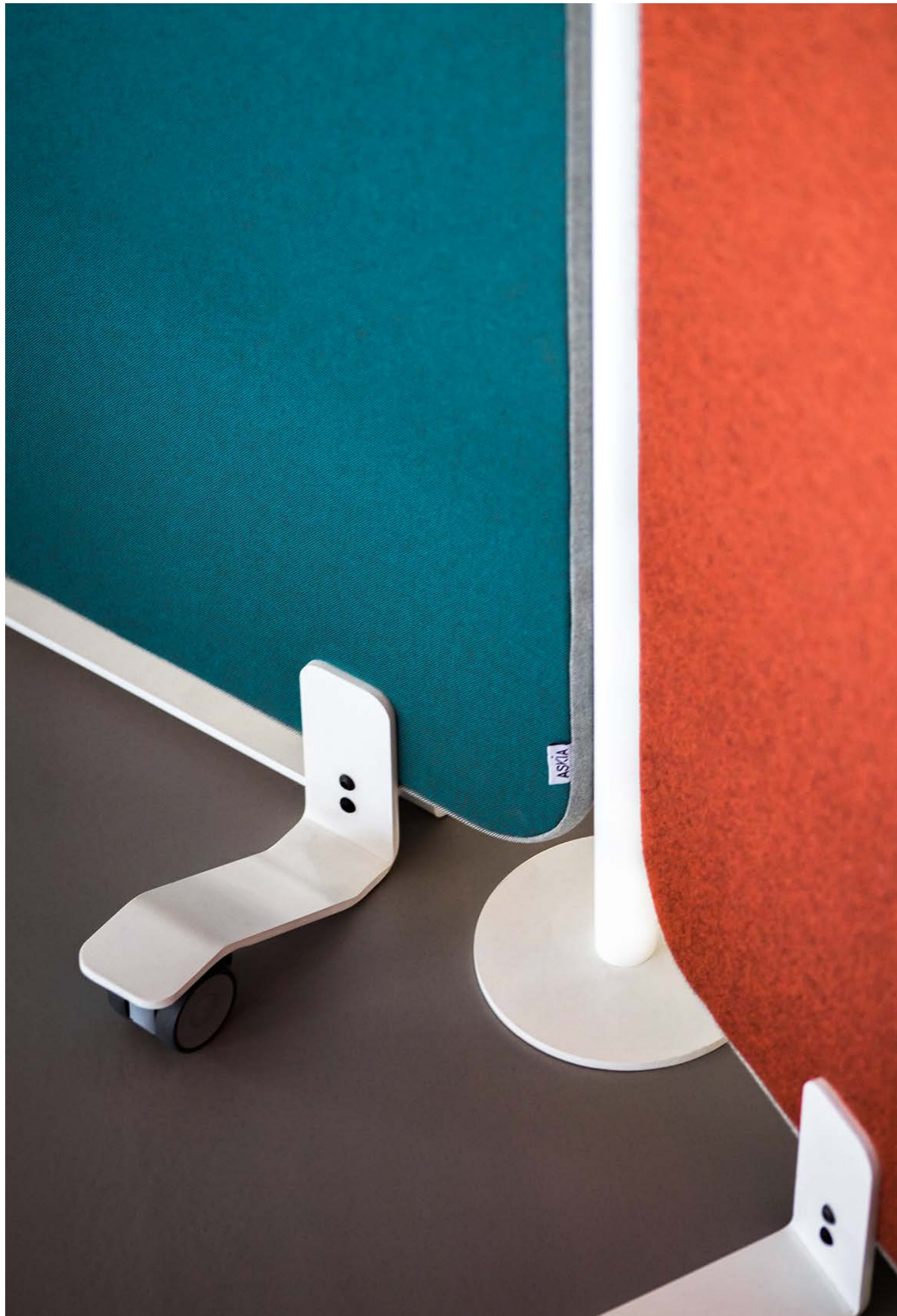

TECHNICAL DETAILS

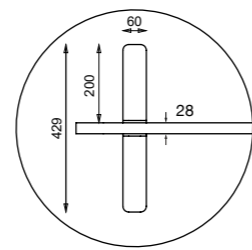
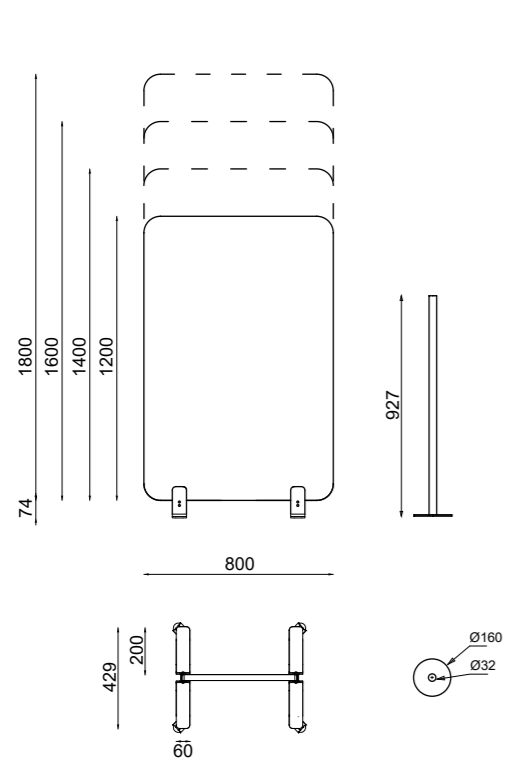

Free Standing Feet
FIX screen

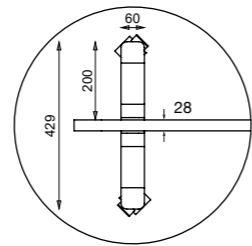

Mobile base
With lockable castors
FLEXI Screen

EASY TO COMBINE

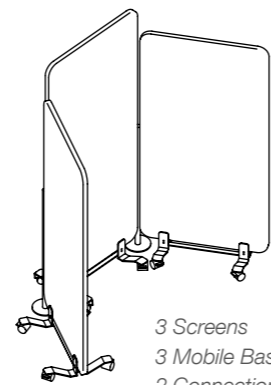
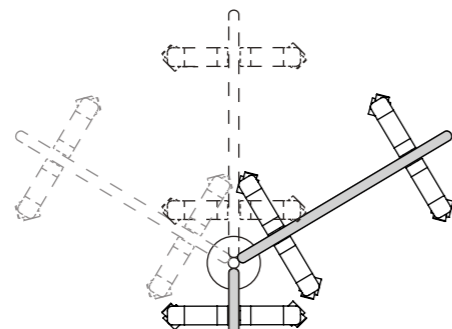
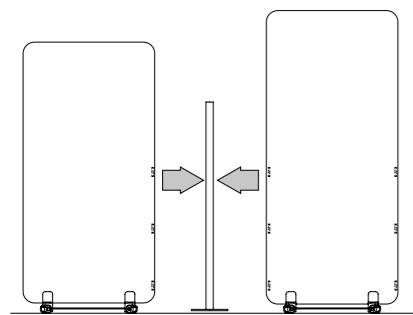

3 Screens
3 Mobile Bases
2 Connection Bars

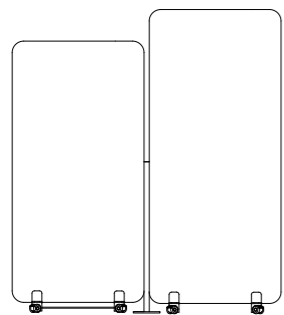

108°, 180°, 250° angle
example of different angles

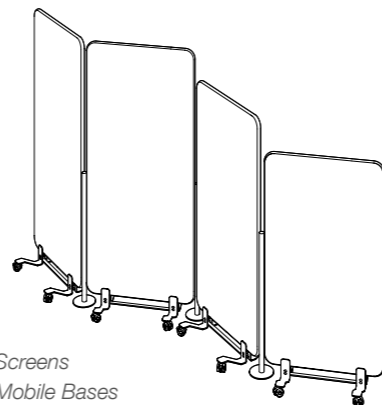
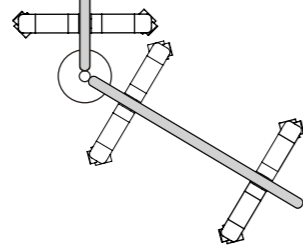

4 Screens
4 Mobile Bases
3 Connection Bars

06

The **CONNECT Collection** offers, through its floor and desk range of screens, multiple solutions for room and desk partitioning. You can **connect** the screens and create your personalized work environment, a meeting room or just separate the workspace. With different acoustic properties available, these panels offer more than visual separation in the fabric options, you can customize your screens to fit your space and vision.

LIGHT TALE
by 201 Design Studio

FIX SCREEN
by ARS

FLEXI SCREEN
by ARS

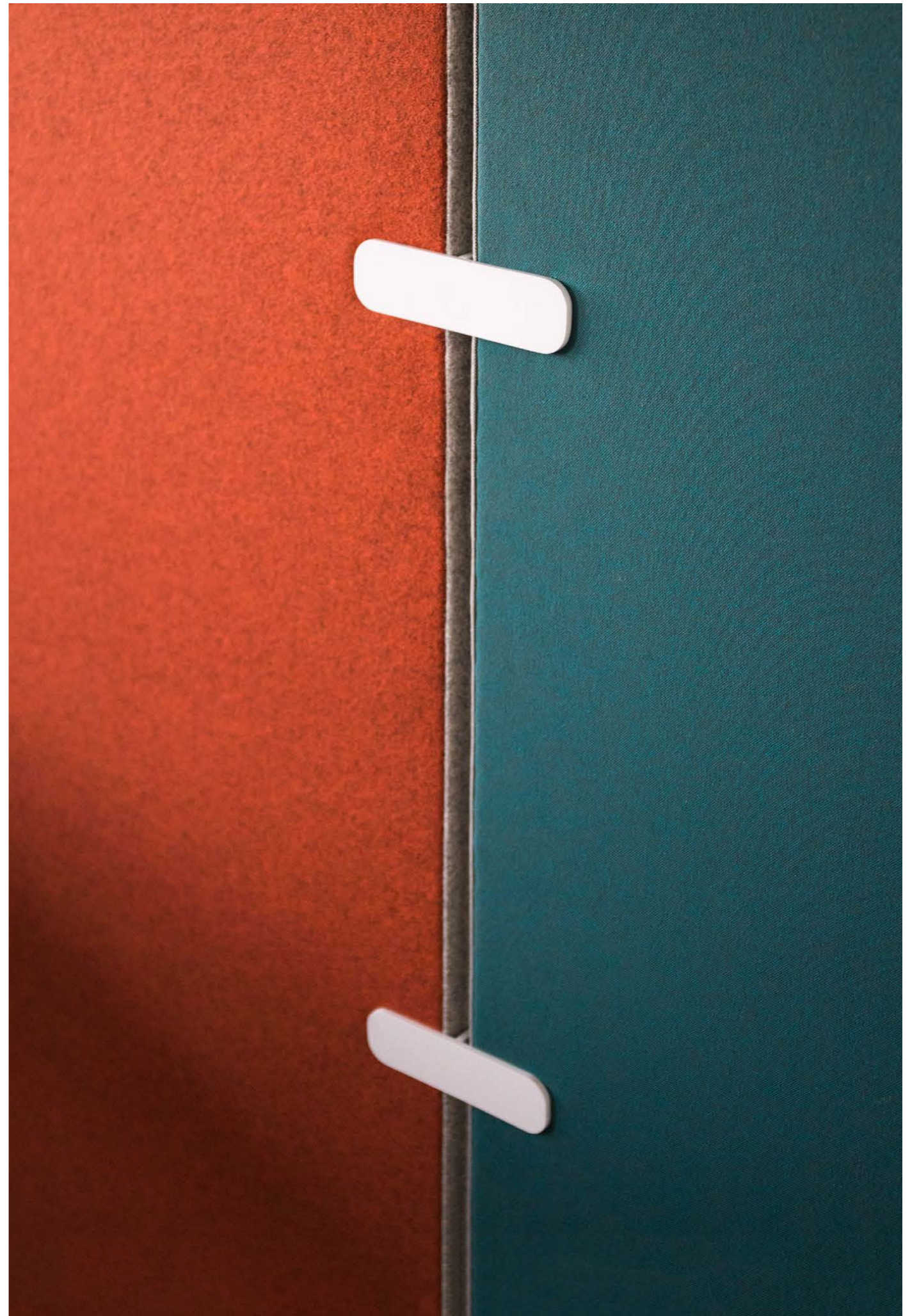

FRONT SCREEN



Attenuation



Absorption



FRONT SCREEN
by ARS

MANAGERIAL DESK
by ARS

The **FRONT SCREENS** share the same versatility and performance as our other screens.

Their installation on the desk is just as simple as it is in the case of our other **CONNECT** screens. Place the screen on the already mounted base on the desk and enjoy a quiet space.

Desk Clamp

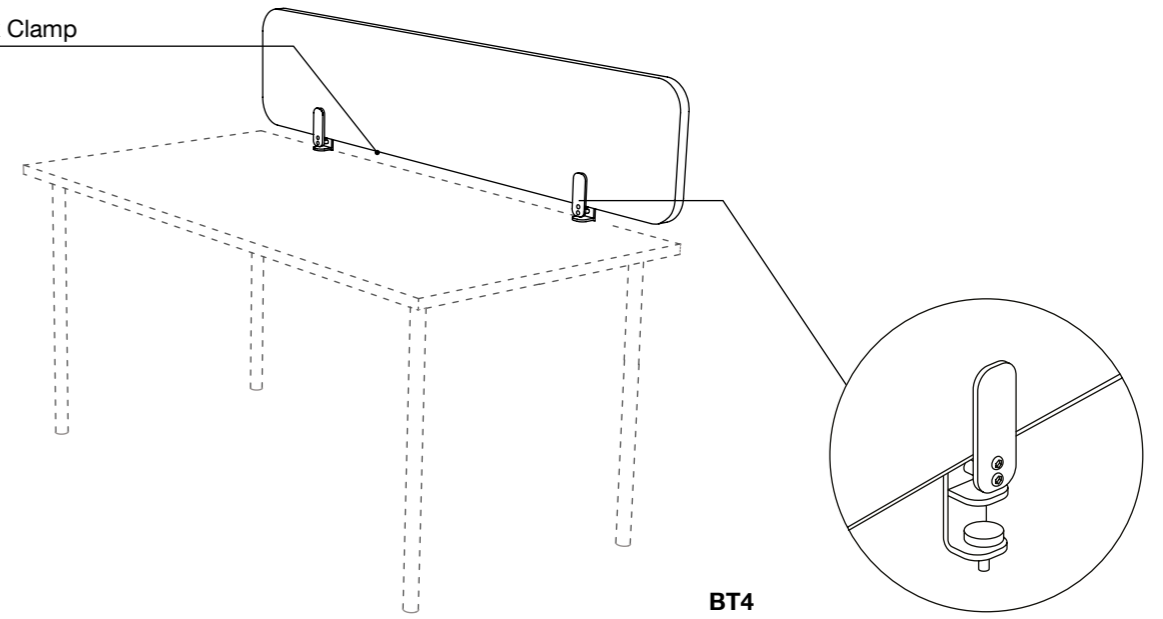

BT4
Desk & Bench
Clamp/Bracket

TECHNICAL DETAILS

fits any conventional desk

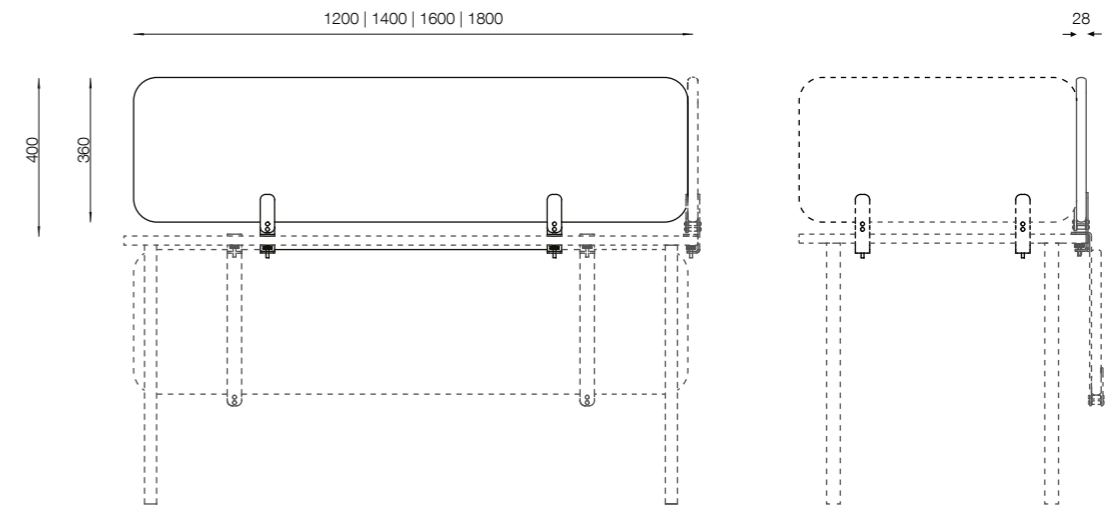

BASE TYPE

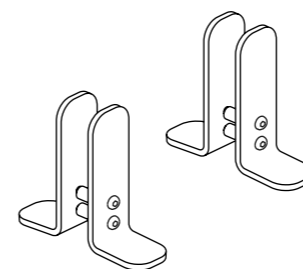

BT3
Free Standing Feet

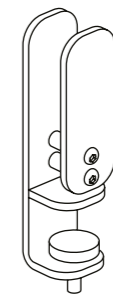

BT4
Desk & Bench
Clamp/Bracket

MODESTY SCREEN



MODESTY SCREEN
by ARS

Create your own workspace,
connect with your work.

The **MODESTY SCREENS** share the same qualities as our vertical screens, but with another purpose. These screens offer more than a visual partition in your office, giving you, your own personal space while working, and separating the lower part of your desk from the rest.

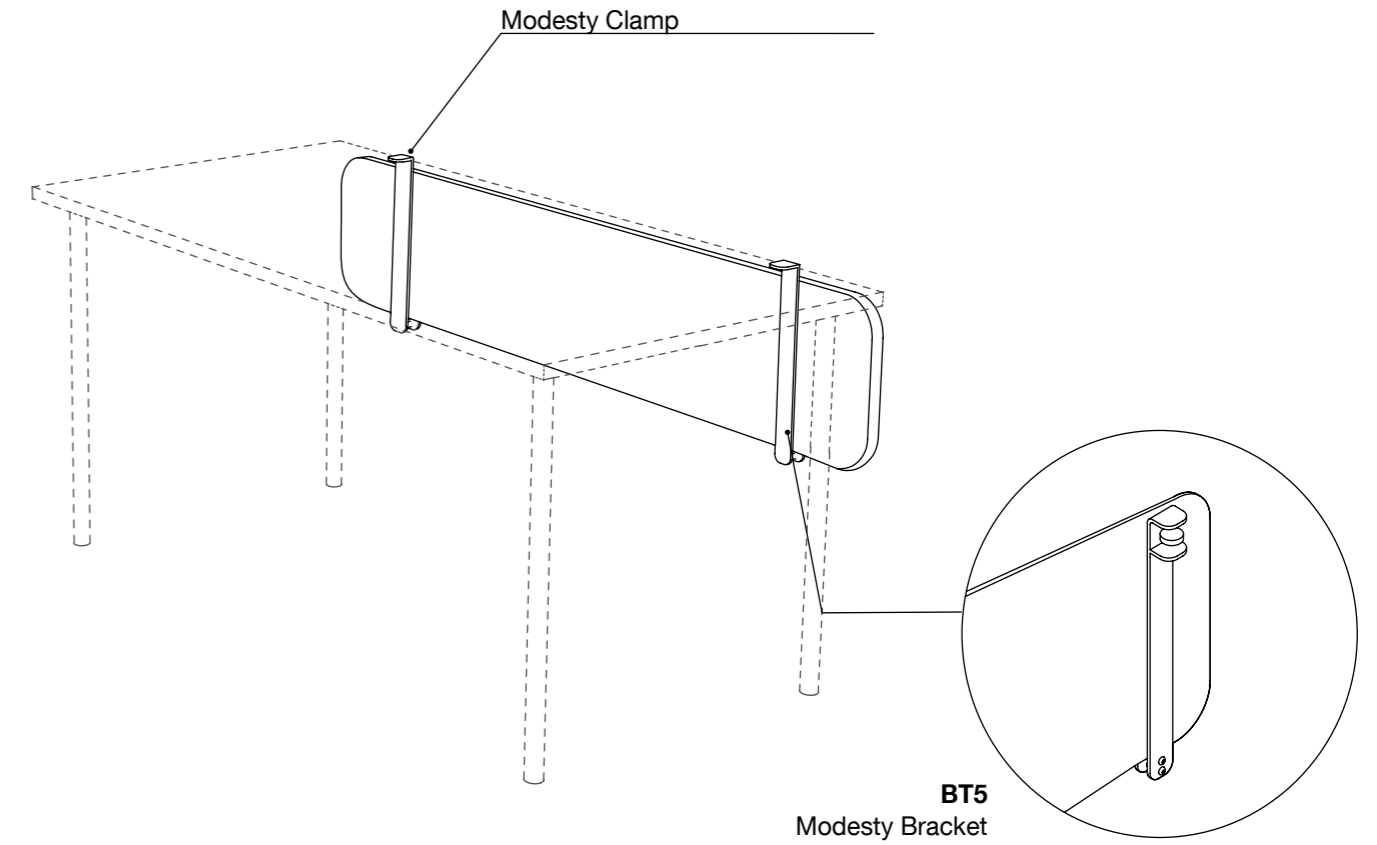

TECHNICAL DETAILS

fits any conventional desk

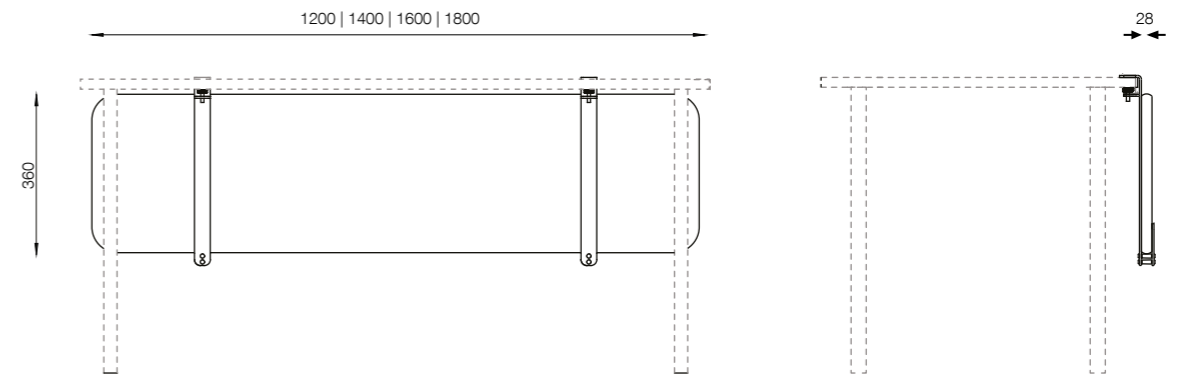

BASE TYPE

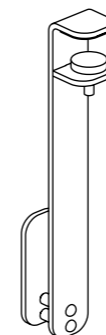

BT5
Modesty Bracket

13

SIDE SCREEN



Attenuation



Absorption

The **SIDE SCREENS** were made with the intention of constantly being rearranged in many ways and serving multiple purposes. They create the much needed feeling of privacy, even if you share your desk with someone else.

SIDE SCREEN
by ARS



NOMAD STOOL
by ARS

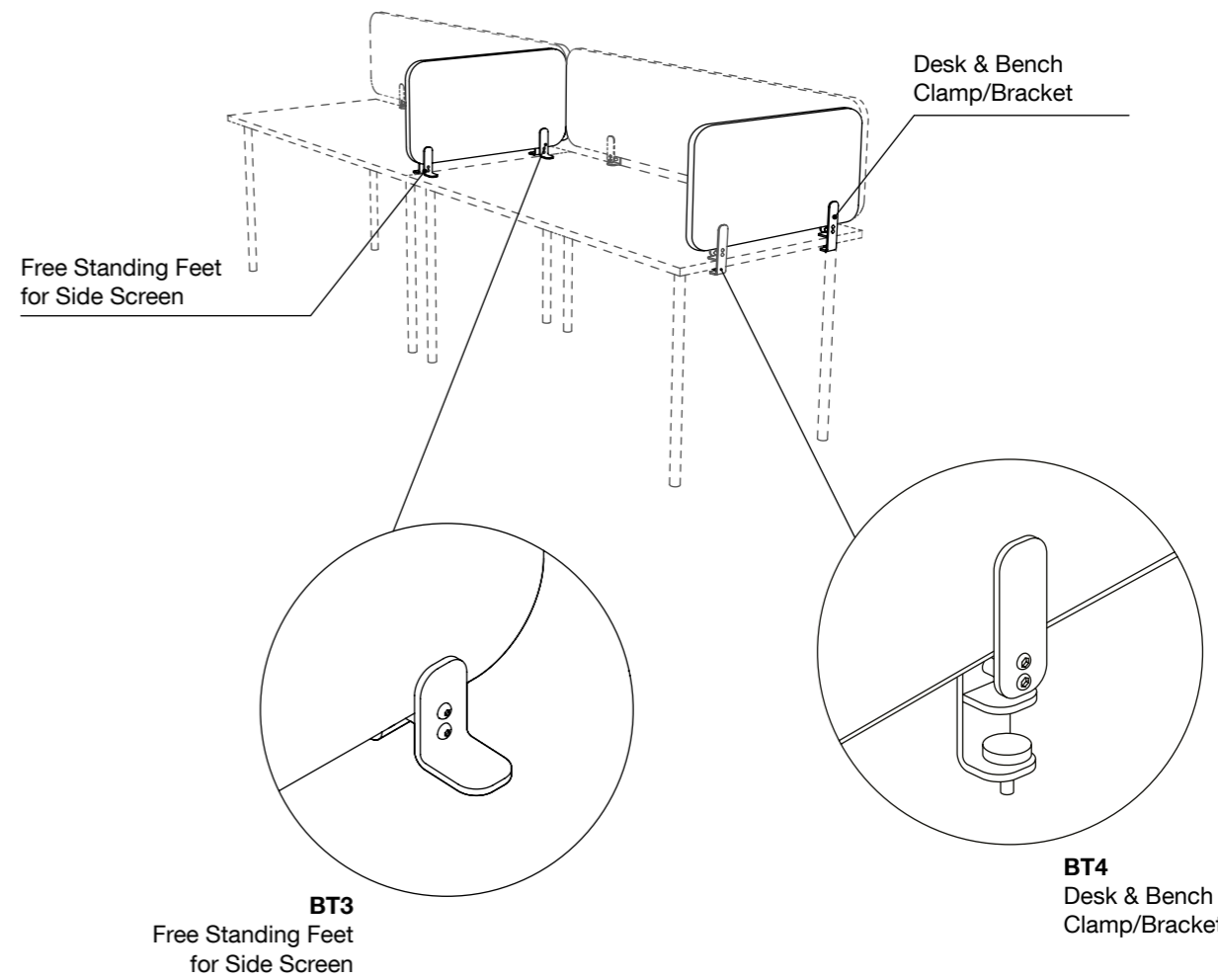

TECHNICAL DETAILS

fits any conventional desk

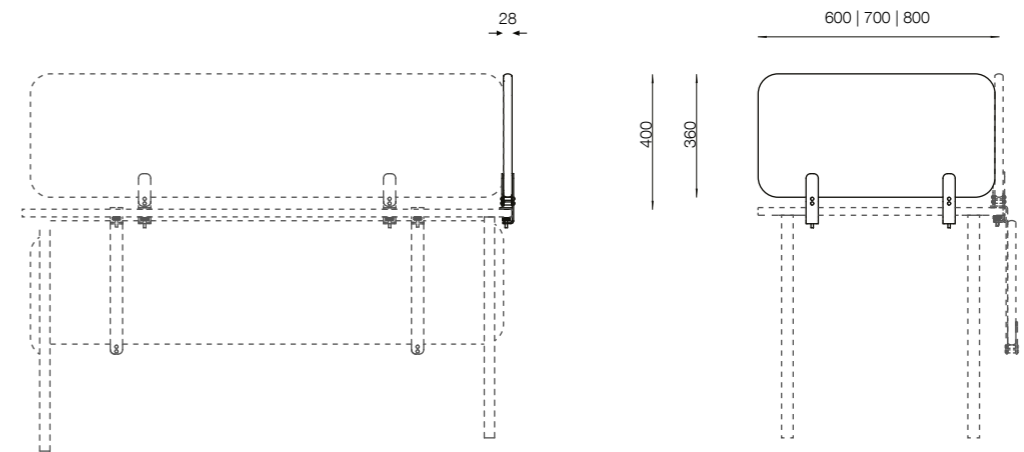

BASE TYPE

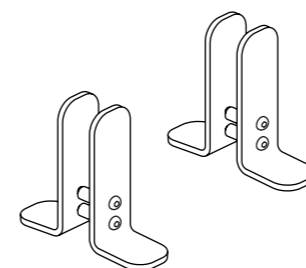

BT3
Free Standing Feet

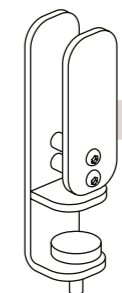

BT4
Desk & Bench
Clamp/Bracket

15

WORKBENCH SCREEN



Attenuation



Absorption

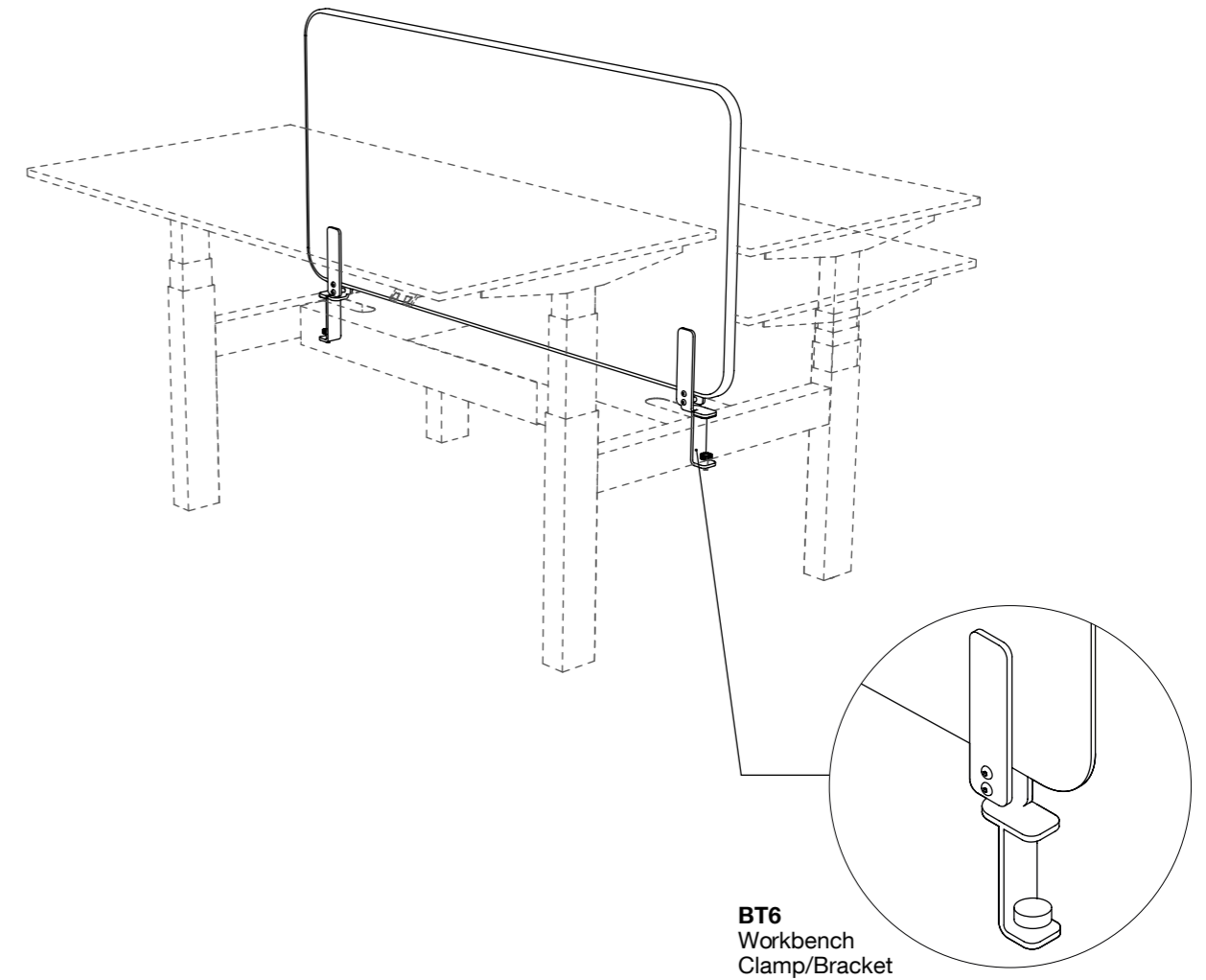

BT6
Workbench
Clamp/Bracket

TECHNICAL DETAILS

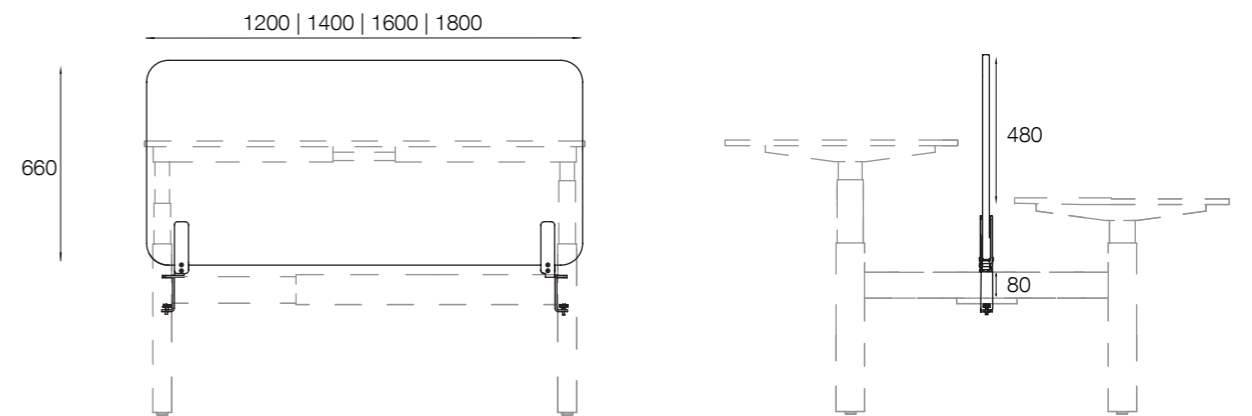

BASE TYPE

fits any conventional bench with 80mm cross bar

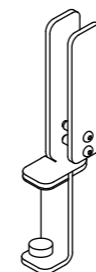

BT6
Workbench
Clamp/Bracket

17

The **WORKBENCH SCREENS** give you your own private space even if you have a desk with adjustable height.

It is easy to place the screen on the already installed brackets, creating your desired place to work.

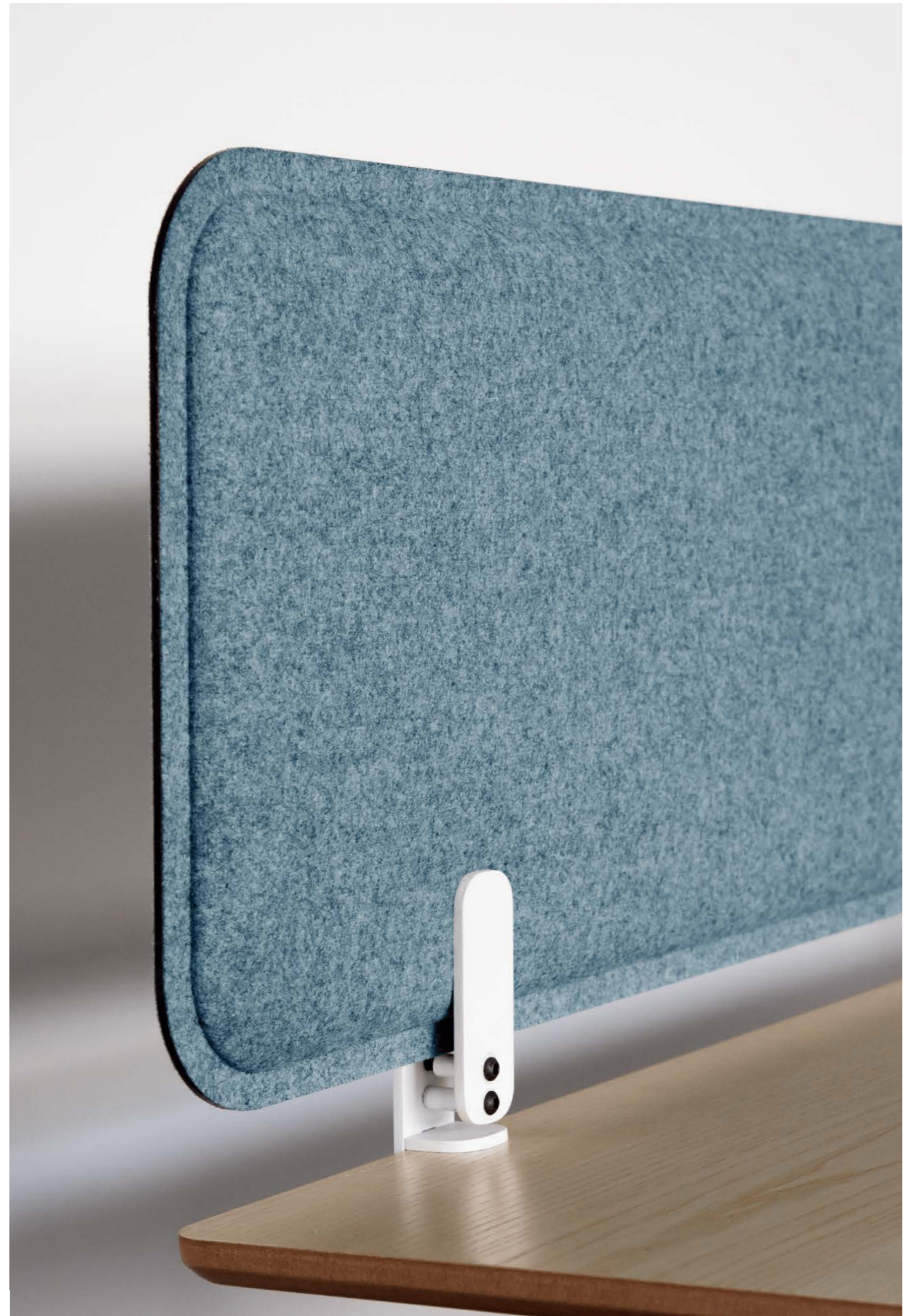

Seamlessly connected
with our **Easy Slide Desks.**



Visit our **Easy Slide Desk collection** catalogue to choose your Desk, Bench or Island, complete with cable management accessories and colorful finish selection. Find out more on our website. www.askiafurniture.ro

METAL

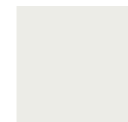

B07
9003



B06
7040

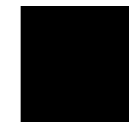

B04
9005

HANGBOARD

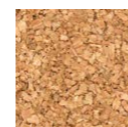

W01
Cork Pinboard



W02
HPL Whiteboard

FABRICS



A01
9201



A02
9302

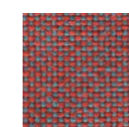

A03
9306

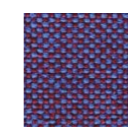

A04
9406



A05
9501



A06
9602



A07
9616

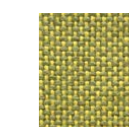

A08
9702



A09
9706

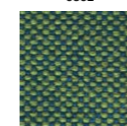

A10
9717



A11
9801



A12
1006



A13
3036



A14
4027

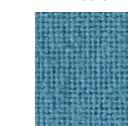

A15
6007



A16
6013



A17
6014

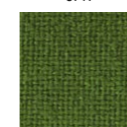

A18
7025

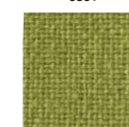

A19
7041



A20
8009



A21
9304



A22
9281

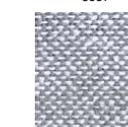

A23
9804



A24
1006



A25
3007



A26
4030



A27
4037



A28
4067



A29
4028

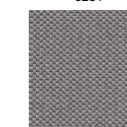

A30
8532



A31
7521



A32
7026



A33
6091

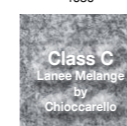

C01
WM101

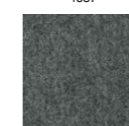

C02
WM103



C03
WM111



C04
WM112



C05
WM120



C06
WM125

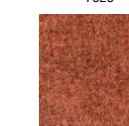

C07
WM126



C08
WM132



C09
WM133



C10
WM139



C11
WM140

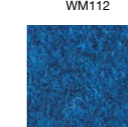

C12
WM142

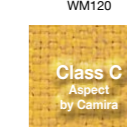

C13
ACT01



C14
ACT03

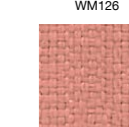

C15
ACT07



C16
ACT09



C17
ACT16



C18
ACT18



C19
ACT20



C20
ACT23

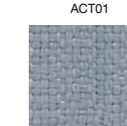

C21
ACT25

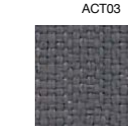

C22
ACT29

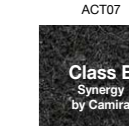

E01
LDS17



E02
LDS22



E03
LDS28



E04
LDS37



E05
LDS53



E06
LDS55

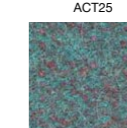

E07
LDS56



E08
LDS57



E09
LDS73



E10

CHIPBOARD

FLOOR SCREENS

FLEXI

Mobile Base	 FIA12BT1 800/1200/28 19.5 kg	 FIA14BT1 800/1400/28 22.5 kg	 FIA16BT1 800/1600/28 24.5 kg	 FIA18BT1 800/1800/28 27.2 kg
-------------	---	---	---	---

Mobile Base Magnetic Edge	 FMA12BT1 800/1200/28 19.5 kg	 FMA14BT1 800/1400/28 22.5 kg	 FMA16BT1 800/1600/28 24.5 kg	 FMA18BT1 800/1800/28 27.2 kg
------------------------------	---	---	---	---

FIX





Fixed Base	 FIA12BT2 800/1200/28 20.5 kg	 FIA14BT2 800/1400/28 23.5 kg	 FIA16BT2 800/1600/28 25.5 kg	 FIA18BT2 800/1800/28 28.2 kg
------------	---	---	---	---

TABLE SCREENS

FRONT SCREEN

Free standing	 FSA12BT3 1200/360/28 8.6 kg	 FSA14BT3 1400/360/28 9.8 kg	 FSA16BT3 1600/360/28 10.9 kg	 FSA18BT3 1800/360/28 12.1 kg
---------------	--	--	---	---

*Dimensions expressed in millimeters: width x height x depth

Desk Clamp	 FSA12BT4 1200/360/28 9 kg	 FSA14BT4 1400/360/28 10.2 kg	 FSA16BT4 1600/360/28 11.3 kg	 FSA18BT4 1800/360/28 12.5 kg
------------	--	---	---	---

SIDE SCREEN

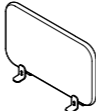
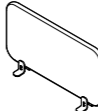
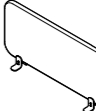
Free standing	 SSA60BT3 600/360/28 4.3 kg	 SSA70BT3 700/360/28 4.9 kg	 SSA80BT3 800/360/28 5.4 kg
---------------	---	---	---

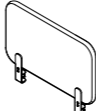
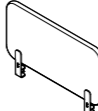
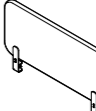
Desk Clamp	 SSA60BT4 600/360/28 4.5 kg	 SSA70BT4 700/360/28 5.1 kg	 SSA80BT4 800/360/28 5.6 kg
------------	--	--	--

MODESTY SCREEN

 MSA12BT5 1200/360/28 9.4 kg	 MSA14BT5 1400/360/28 10.8 kg	 MSA16BT5 1600/360/28 11.9 kg	 MSA18BT5 1800/360/28 13.1 kg
--	---	---	---

WORKBENCH SCREEN

 WSA12BT6 1200/660/28 11.5 kg	 WSA14BT6 1400/660/28 12.7 kg	 WSA16BT6 1600/660/28 13.8 kg	 WSA18BT6 1800/660/28 15 kg
---	---	---	---

*Dimensions expressed in millimeters: width x height x depth

ACOUSTIC PET FELT

FLOOR SCREENS

FLEXI

Mobile Base	 FLB12BT1 800/1200/28 19.5 kg	 FLB14BT1 800/1400/28 22.5 kg	 FLB16BT1 800/1600/28 24.5 kg	 FLB18BT1 800/1800/28 27.2 kg
-------------	---	---	---	---

Mobile Base Magnetic Edge	 FMB12BT1 800/1200/28 19.5 kg	 FMB14BT 800/1400/28 22.5 kg	 FMB16BT1 800/1600/28 24.5 kg	 FMB18BT1 800/1800/28 27.2 kg
------------------------------	---	--	---	---

FIX







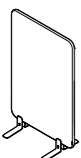

Fixed Base	 FIB12BT2 800/1200/28 20.5 kg	 FIB14BT2 800/1400/28 23.5 kg	 FIB16BT2 800/1600/28 25.5 kg	 FIB18BT2 800/1800/28 28.2 kg
------------	---	---	---	---

TABLE SCREENS

FRONT SCREEN



Free standing	 FSB12BT3 1200/360/28 8.6 kg	 FSB14BT3 1400/360/28 9.8 kg	 FSB16BT3 1600/360/28 10.9 kg	 FSB18BT3 1800/360/28 12.1 kg
---------------	--	--	---	---

*Dimensions expressed in millimeters: width x height x depth

Desk Clamp	 FSB12BT4 1200/360/28 9 kg	 FSB14BT4 1400/360/28 10.2 kg	 FSB16BT4 1600/360/28 11.3 kg	 FSB18BT4 1800/360/28 12.5 kg
------------	--	---	---	---

SIDE SCREEN

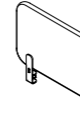
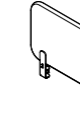
Free standing	 SSB60BT3 600/360/28 4.3 kg	 SSB70BT3 700/360/28 4.9 kg	 SSB80BT3 800/360/28 5.4 kg
---------------	---	---	---

Desk Clamp	 SSB60BT4 600/360/28 4.5 kg	 SSB70BT4 700/360/28 5.1 kg	 SSB80BT4 800/360/28 5.6 kg
------------	--	--	--

MODESTY SCREEN

 MSB12BT5 1200/360/28 9.4 kg	 MSB14BT5 1400/360/28 10.8 kg	 MSB16BT5 1600/360/28 11.9 kg	 MSB18BT5 1800/360/28 13.1 kg
--	---	---	---

WORKBENCH SCREEN

 WSB12BT6 1200/660/28 11.5 kg	 WSB14BT6 1400/660/28 12.7 kg	 WSB16BT6 1600/660/28 13.8 kg	 WSB18BT6 1800/660/28 15 kg
---	---	---	---





*Dimensions expressed in millimeters: width x height x depth

THERMOFORMED



TABLE SCREENS

FRONT SCREEN

Free standing



			
FST12BT3 1200/360/31 8.6 kg	FST14BT3 1400/360/31 9.8 kg	FST16BT3 1600/360/31 10.9 kg	FST18BT3 1800/360/31 12.1 kg

Desk Clamp

			
FST12BT4 1200/360/31 9 kg	FST14BT4 1400/360/31 10.2 kg	FST16BT4 1600/360/31 11.3 kg	FST18BT4 1800/360/31 12.5 kg

SIDE SCREEN





Free standing

		
SST60BT3 600/360/31 4.3 kg	SST70BT3 700/360/31 4.9 kg	SST80BT3 800/360/31 5.4 kg

Desk Clamp

		
SST60BT4 600/360/31 4.5 kg	SST70BT4 700/360/31 5.1 kg	SST80BT4 800/360/31 5.6 kg

MODESTY SCREEN

			
MST12BT5 1200/360/31 9.4 kg	MST14BT5 1400/360/31 10.8 kg	MST16BT5 1600/360/31 11.9 kg	MST18BT5 1800/360/31 13.1 kg

*Dimensions expressed in millimeters: width x height x depth

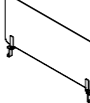

WORKBENCH SCREEN

			
WST12BT6 1200/660/31 11.5 kg	WST14BT6 1400/660/31 12.7 kg	WST16BT6 1600/660/31 13.8 kg	WST18BT6 1800/660/31 15 kg

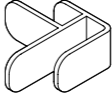
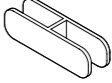
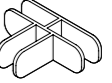
CONNECTORS

			
FLC 924/160/28 4.3 kg	FIC* 100/100 2 kg *sold as a pair	FIS* 140/36 1.9 kg *sold as a pair	FIT* 140/100 2.2 kg *sold as a pair

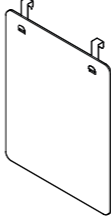
ACCESORIES

	
PWB 850/730 2 KG	HGR* 135/40 0.1 KG *sold as a pair

*Dimensions expressed in millimeters: width x height x depth

Order form model

FLEXI

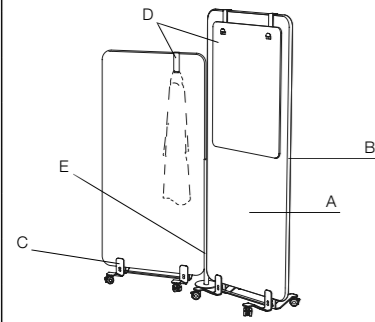

Index Code	FLA12BT1
Face color* (A)	A20
Edge color* (B)	A21
Base color (C)	B07
Accessories* (D)	PWB, HGR
Accessories color*	B07
Connector (E)	FLC
Connector color*	B07
Code format	FLA12BT1 A20A21B07 PWBB07 HGRB07 FLCB07

FIX

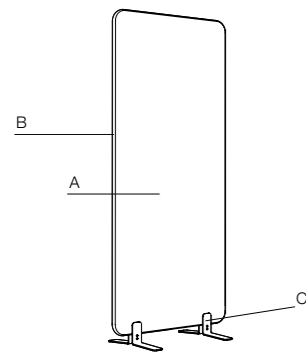

Index Code	FIA12BT1
Face color* (A)	A20
Edge color* (B)	A21
Base color (C)	B07
Accessories* (D)	-
Accessories color*	-
Connector (E)	-
Connector color*	-
Code format	FIA12BT1 A20A21B07

FRONT SCREENS, SIDE SCREENS

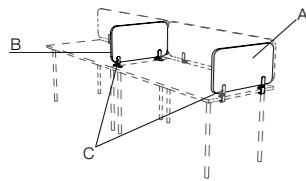

Index Code	FSA12BT3, SSA12BT3
Face color (A)	A20
Edge color (B)	A21
Base color (C)	B07
Code format	FSA12BT3 A20A21B07, SSA12BT3 A20A21B07

MODESTY SCREENS

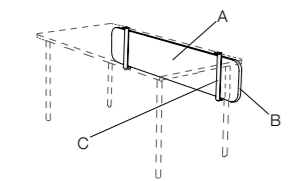

Index Code	MSA12BT5
Face color (A)	A20
Edge color (B)	A21
Base color (C)	B07
Code format	MSA12BT5 A20A21B07

WORKBENCH SCREENS

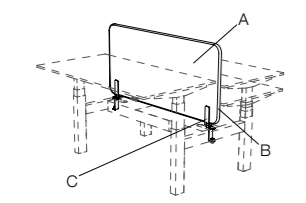

Index Code	WSA12BT6
Face color (A)	A20
Edge color (B)	A21
Base color (C)	B07
Code format	WSA12BT6 A20A21B07

*for colour options see page 21
 *accessories and connectors must be the same color
 *panel and edge fabric must be from the same collection



ASKIA

Eliade Tower,
Mircea Eliade Nr.18
RO-Bucuresti, 012015

T +40 212 121 381
contact@askiafurniture.ro

www.askiafurniture.ro