

ZEN SOUNDSHAPER® WALL & CEILING COLLECTION



STEELBOX
STEEL&STYLE

“L'unico modo di fare un ottimo lavoro è amare quello che fai. Se non hai ancora trovato ciò che fa per te, continua a cercare, non fermarti, come capita per le faccende di cuore, saprai di averlo trovato non appena ce l'avrai davanti. E, come le grandi storie d'amore, diventerà sempre meglio col passare degli anni. Quindi continua a cercare finché non lo troverai. Non accontentarti. Sii affamato. Sii folle.”

“The only way to be truly satisfied is to do what you believe is a great job. And the only way to do a great job is to love what you do. If you haven't found it yet, keep looking. Don't settle. As with all the matters of the heart, you'll know when you find it. And, like any great relationship, it just gets better and better as the years roll on. So keep looking until you find it. Don't settle. Stay hungry. Stay foolish.”

Steve Jobs



CEO
LORELLA PEDICONE

Un'eredità storica da preservare, un mercato da soddisfare, nuovi prodotti da ideare e molti altri obiettivi da raggiungere, sono alcuni dei punti fermi della strategia aziendale della divisione Steelbox di Metalway S.r.l.

Il marchio Steelbox raccoglie tutta la sapienza di un produttore che per 20 anni ha saputo trasformare semplice lamiera in contenimento e strutture che migliorano ogni giorno la vostra esperienza lavorativa.



Grazie alla ventennale esperienza e preparazione di Metalway nella lavorazione del ferro, tecnologia, know how e nuove lavorazioni si amalgamano creando oggetti adatti a supportare l'utente nelle nuove sfide del lavoro moderno.

Coniugando il know-how industriale con una visione lungimirante del futuro, il marchio Steelbox si candida come partner ideale del cliente che è alla ricerca di affidabilità e qualità, parole d'ordine in ogni reparto di produzione aziendale. Situata nella zona industriale di Tortoreto, l'azienda Metalway S.r.l. ha dedicato alla Steelbox ben

A historical legacy to preserve, a market to satisfy, new products to design and much more goals to achieve, are some of the key points of the business strategy for the Steelbox division of Metalway Ltd.

The brand Steelbox collects all the wisdom of a manufacturer who for 20 years has been able to transform simple steel foil into containment and structures able to improve your daily work experience. Preparation and experience come together in Metalway, with twenty years of experience in metal working, mixes

technology, experience and new processes, we mix to create new objects suitable to support the user in the challenging modern workplace.

Combining the industrial know-how with a farsighted vision of the future, the brand Steelbox is the ideal partner of the customer who is looking for reliability and quality, mottoes in every production department of the Company.

Located in the industrial zone of Tortoreto, the company Metalway Ltd dedicated to Steelbox division 5.000 square meters of its total surface, with numerical control machines and an

5000 mq. di superficie, macchinari innovativi a controllo numerico associati a un capitale umano inestimabile. La Steelbox produce una gamma di mobili metallici che possono soddisfare ogni richiesta del mercato, completata da una scaffalatura leggera, componibile e adatta anche ad ambienti pubblici. Armadi polifunzionali, panche per spogliatoi tavoli mensa, pannelli acustici, tavoli da caffè e prodotti per horeca arricchiscono il pacchetto, soddisfacendo ogni esigenza di mercato. Dal 2018 è stata introdotta



una collezione di pannelli acustici che ha proiettato definitivamente l'azienda nel mondo del design e del contract. Attraverso la sua rete capillare di distribuzione in Italia e all'estero, la Steelbox si propone di migliorare tramite il confronto con il mercato, attuando soluzioni in sincronia con i propri rivenditori e agenti, per trasformare ogni prodotto in un arredo speciale.

Il centro studi e ricerche della divisione Steelbox in collaborazione con i tecnici della Metalway, con architetti e ingegneri specializzati, sfida giornalmente le leggi dell'ergonomia e della fisica

irreplaceable human capital, to produce a range of metal furniture that can satisfy every demand of the market, complemented by a lightweight shelving system, modular and suitable to public spaces. Multifunctional locker cabinets, locker room benches, canteen tables, acoustic panels, coffee tables and horeca products complete the package, satisfying every need of the market. Since 2018, a collection of acoustic panels has been introduced, which has definitively projected the company into the world of design and contract.



per plasmare il semplice metallo e altri materiali realizzando oggetti adatti a potenziare il vostro lavoro quotidiano. Gli ordini accuratamente controllati e confermati dal nostro ufficio vendite, sono inseriti nel potente sistema informatico che permette al nostro team di gestione di eseguire immediatamente ordini di materie prime e produzione di tutti gli elementi richiesti. Il prodotto è sottoposto a stretti controlli di qualità durante le fasi di tranciatura, presso piegatura, foratura e saldatura di precisione eseguita da



All the orders, carefully checked and confirmed by our sales department are entered in the powerful IT system that allows our management team to execute immediately orders of raw materials and production of all required elements.

The product is subjected to strict quality controls during cutting, press folding, drilling and precision welding performed by anthropomorphic robots. The final step of coating is realized with epoxy powders after a treatment of phosphor-degreasing. The packaging made with care and the preparation



Through its extensive network of distribution in Italy and abroad, Steelbox aims to improve every day facing the market challenges, implementing solutions according with its dealers and agents, to turn every product into a special furniture.

The Research and Development center of the Steelbox, in cooperation with the technical department of Metalway, architects and engineers, are daily challenging the laws of ergonomics and physics to shape the simple metal and other materials to create articles to empower your daily work.

robot antropomorfi. La fase finale di verniciatura è realizzata con polveri epossipoliesteri previo trattamento di fosfo-sgrassaggio. L'imballaggio eseguito con cura e la preparazione del prodotto già destinato alla vendita, completano il processo di qualità, che permette alla Steelbox di conquistare anche i mercati più esigenti.

La determinazione e gli sforzi del team di lavoro orientato al mercato, contribuiscono a creare quello che per noi è lo Steel & Style, un'importante sfida d'innovazione e qualità che appaga il nostro lavoro e la necessità del nostro cliente.

of the product to be shipped, complete the quality process, which allows Steelbox to conquer even the most demanding markets.

The determination and efforts of our market oriented team work, are helping to create what for us is the Steel & Style, a major challenge for innovation and quality that satisfies our work and our customer's needs.

www.steelbox.it

ZEN Square

Un pannello a geometria regolare, il pannello Zen Square, pannello acustico monofacciale, arreda con eleganza e con simmetria l'ambiente. Disponibile a pannelli singoli, doppi e quadrati, sono adatti per essere utilizzati sulle pareti o dal soffitto. Il pannello Zen square liscio è anche personalizzabile con immagini e loghi.

A panel with regular geometry, Zen Square panel, a single-sided acoustic panel, furnishes the environment with elegance and symmetry. Available in single, double and square panels, they are suitable for use on walls or from the ceiling. The Zen square flat is customizable with images and logo.



Scarica la brochure.
Download the leaflet.



Scarica il technical book.
Download the technical book.











Supporto CEILP645
Bracket



Supporto CEILP690
Bracket



I pannelli monofacciali Zen Square possono essere utilizzati in vari modi, a soffitto o parete attraverso dei supporti metallici, CEILP645, CEILP690, CEILP045 e CEILP090, e si possono sovrapporre per ottenere un gradevole effetto ottico tridimensionale. Altri supporti, quali velcro e cavetti bilanciati in acciaio, sono disponibili a catalogo, per ottenere un arredamento innovativo e flessibile. Inoltre i pannelli Zen Square 59x59 cm possono sostituire i comuni pannelli in fibra utilizzati nei controsoffitti.

One-side Zen Square panels can be used with different fixings. If used with the CEILP645, CEILP690, CEILP045 and CEILP090 brackets, they can be overlapped to obtain a nice 3D-dimensional optical effect. Other supports such as Magnets, Velcro, and steel cable Balancer, are available in the catalog, to get a fancy and flexible furnishing. The Zen Square panel 59x59 cm can replace the common fiber panels used in false ceilings.



Coppia di adesivi KITVELFE con velcro e piastrino in metallo che si utilizzano per fissaggi su superfici ruvide. Dimensioni del velcro/piastrino cm ø 8.

Pair of stickers KITVELFE with velcro and metal plate are used for fixing on any rough surface. Dimension of the Velcro/metal plate cm ø 8.

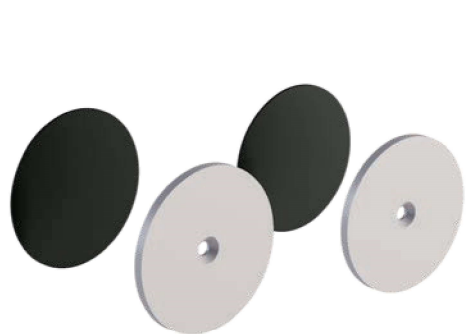

I dischetti in Velcro KITVELCR sono utilizzabili su qualsiasi superficie liscia e sono adatti per un riposizionamento facile e veloce su pareti che non possono essere forate. Il Velcro è utilizzabile solo per i pannelli MONOFACCIALI.

The Velcro discs KITVELCR can be used on any smooth surface and are useful to ease the repositioning and to fix the panels on walls that cannot be drilled. The Velcro can be used for ONE SIDE panels only.

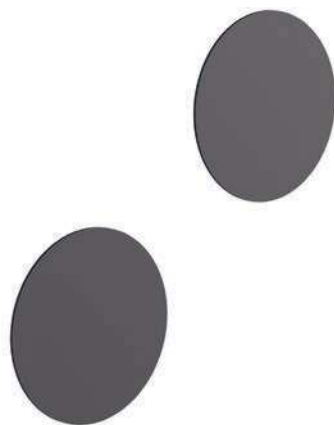

IL TELPA118 è il telaio di installazione a soffitto per Pannello Acustico ZEN Square pan059x4 con 4 cavi in acciaio inclusi.

The TELPA118 is the installation frame for ceiling for Acoustic Panel Zen Square pan059x4 with 4 steel cables included.



Il CEIL2CONTORI è uno speciale kit a bilanciere per i pannelli cm 59x59 Zen Square. Sostenuto da cavetti in acciaio permette di creare delle piccole isole acustiche.

The CEIL2CONTORI is a special Balancier kit for cm 59x59 panels Zen Square. Suspended by steel cables it allows the creation of small acoustic clouds.

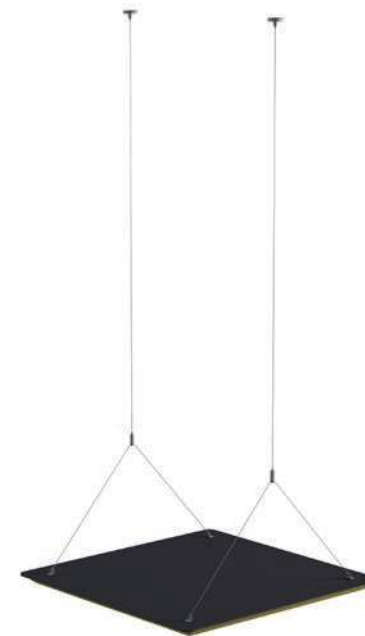

ZEN SQUARE LISCIO PERSONALIZZABILE CON STAMPA

Zen square flat printable with custom image

Scopri la nuova aggiunta alla collezione Zen Square: il nostro innovativo pannello che unisce perfettamente comunicazione, design personalizzato e ottimizzazione acustica. Trasforma il tuo spazio con questo elegante pannello fonoassorbente, facilmente montato sulla parete come un'opera d'arte. Scegli tra una gamma di opzioni, tra cui la tua immagine preferita, il logo dell'azienda o il prodotto, per creare un ambiente veramente su misura che rifletta il tuo stile individuale.

Discover the latest addition to the Zen Square collection - our innovative panel that seamlessly combines communication, personalized design, and acoustic optimization. Transform your space with this stylish sound-absorbing panel, effortlessly mounted on your wall like a work of art. Choose from a range of options including your favorite image, company logo, or product to create a truly bespoke environment that reflects your individual style. Make a statement with our customizable panels and redefine your space



L 59 x H 118 cm



L 118 x H 118 cm

La stampa del pannello ZEN SQUARE LISCIO STAMPABILE è totalmente personalizzabile con qualsiasi immagine a colori. Sarà necessario inviare insieme all'ordine un file PDF/JPG/PNG con una immagine a 300DPI. Assicurarsi di avere tutti i diritti di riproduzione prima di richiedere la stampa, l'azienda declina ogni responsabilità per eventuali copyright.

The PRINTABLE ZEN SQUARE FLAT panel print is fully customizable with any color image. A PDF/JPG/PNG file with a 300DPI image must be sent along with the order. Make sure you have all reproduction rights before requesting printing, the company declines all responsibility for any copyright.



Pannello acustico Zen Square liscio cm L118xH118 con lampada led e kit di fissaggio
Acoustic panel Zen Square flat cm W118xH118 with LED Lamp complete with mounting kit

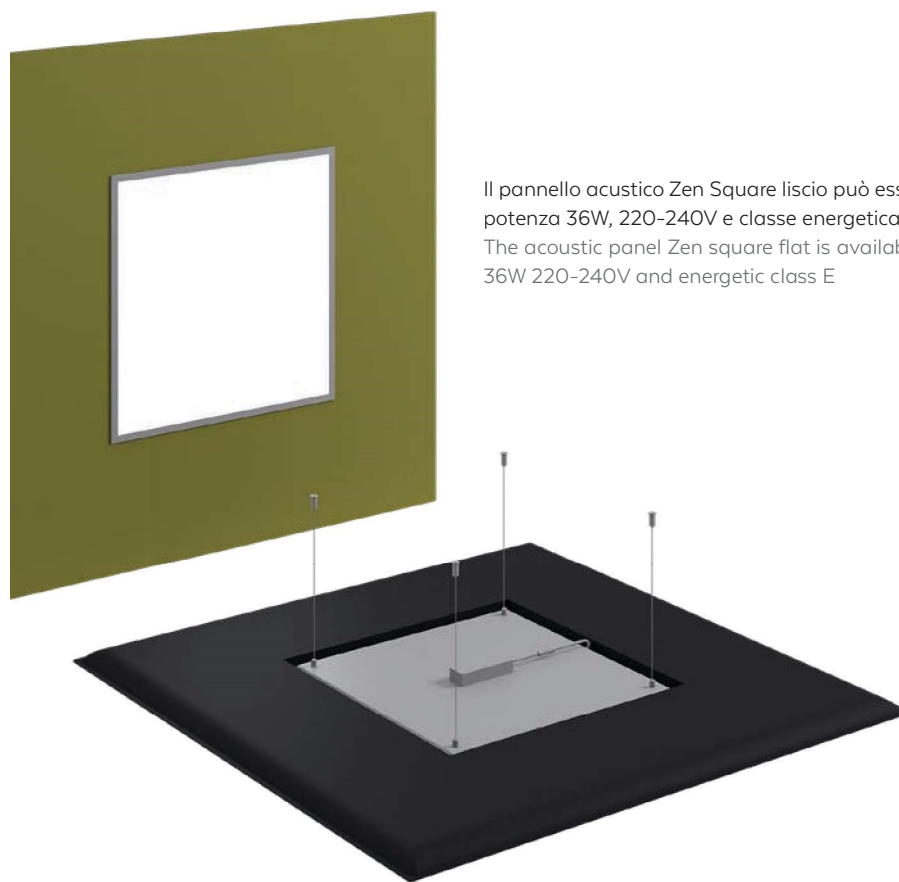

Il pannello acustico Zen Square liscio può essere dotato di lampada Led 3600lm, a 4000K, potenza 36W, 220-240V e classe energetica E.
The acoustic panel Zen square flat is available with LED lamp with 3600lm, 4000K, power 36W 220-240V and energetic class E

Zen Square flat panel

59 x 59 cm
59 x 118 cm
118 x 118 cm

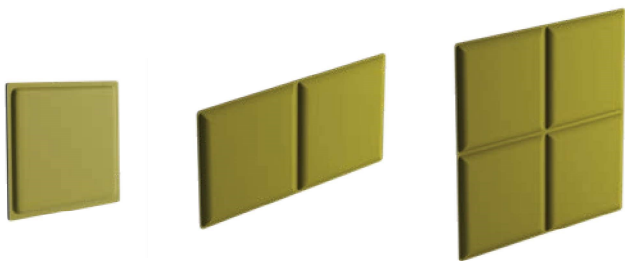

Zen Square liscio stampato
Zen Square flat printed

59 x 118 cm
118 x 118 cm
118x 118 cm



Zen Square panel

59 x 59 cm
59 x 118 cm
118 x 118 cm

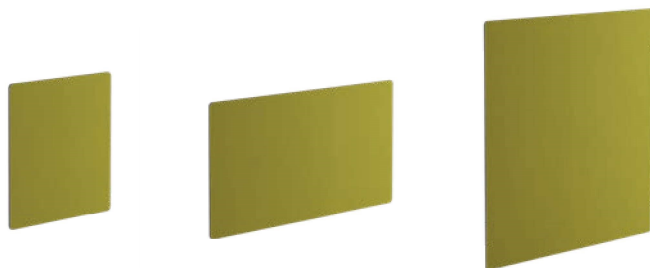

Zen Square Lampada
Zen Square lamp

118 x 118 cm

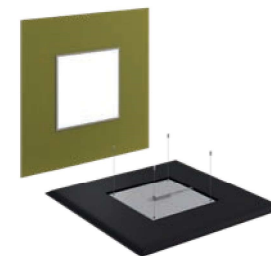

DESCRIZIONI TECNICHE

TECHNICAL FEATURES

PANNELLO ZEN SQUARE

I pannelli monofacciali sono realizzati in fibra di poliestere riciclata, termoformata e tagliata a laser. La fibra è rivestita con tessuto bi-elastico stretch "TREVIRA CS" da un solo lato, senza l'inserito in honeycomb. Nel lato non a vista, il pannello è rivestito con telina nera adatta per il fissaggio a Velcro.

PANELLO SQUARE STAMPATO

La stampa del pannello ZEN SQUARE LISCIO STAMPABILE è totalmente personalizzabile con qualsiasi immagine a colori. Sarà necessario inviare insieme all'ordine un file PDF/JPG/PNG con una immagine a 300DPI. Assicurarsi di avere tutti i diritti di riproduzione prima di richiedere la stampa, l'azienda declina ogni responsabilità per eventuali copyright.

LAMP59X4: Pannello acustico Zen Square liscio cm L 118x118 con lampada Led integrata, compreso di kit di sospensione per soffitto 3600lm, a 4000° K, potenza 36W, 220-240V e classe energetica E.

Altre tipologie Kelvin disponibili su richiesta

CARATTERISTICHE DI RESISTENZA AL FUOCO DEL TESSUTO "TREVIRA CS"

Italia - Classe 1 / Germania - B1 DIN 4102 / Francia - M1 / Austria - B1 OENORM B3825 - Q1 OENORM 3800 Part. 1 - BS 5852 Crib 5 using a CM Foam 35 kg/cu.m - EN 1021 Part.1-2 using a CM Foam 35 kg/cu.m - USA Calif. Bull. 117 June 2013 - EN 13501 - 1,2 : B-s1, d0 - EN 13773 Burning Behaviour: class 1 - EN ISO 6940/6941 / Svizzera - Fire Protection Classification: 5.3

ZEN SQUARE PANELS

The one side panels are made by recycled polyester fiber. The edges of the panels are laser cut. Panels are upholstered with double stretch fabric "TREVIRA CS" on one side only and without the honeycomb insert. On the non-visible side, the panel is covered with a black cloth suitable for Velcro fastening.

PANEL SQUARE STAMPATO

The PRINTABLE ZEN SQUARE FLAT panel print is fully customizable with any color image. A PDF/JPG/PNG file with a 300DPI image must be sent along with the order. Make sure you have all reproduction rights before requesting printing, the company declines all responsibility for any copyright.

LAMP59X4: Zen Square smooth acoustic panel measuring 118x118 cm with integrated LED lamp, including a suspension kit for ceilings. The LED lamp has a brightness of 3600 lumens, a color temperature of 4000K, power consumption of 36W, operates at 220-240V, and has an energy efficiency class of E.

Other Kelvin gradation available upon request

FIRE RETARDANT FABRIC FEATURES "TREVIRA CS"

Italy- Classe 1 / Germany- B1 DIN 4102 / France - M1 / Austria - B1 OENORM B3825 - Q1 OENORM 3800 Part. 1 - BS 5852 Crib 5 using a CM Foam 35 kg/cu.m - EN 1021 Part.1-2 using a CM Foam 35 kg/cu.m - USA Calif. Bull. 117 June 2013 - EN 13501 - 1,2 : B-s1 , d0 - EN 13773 Burning Behaviour: class 1 - EN ISO 6940/6941 / Switzerland - Fire Protection Classification: 5.3

COLORI TESSUTO TREVIRA CS

FABRIC TREVIRA CS COLOR



GIALLO
Yellow
0053



ARANCIO
Orange
0120

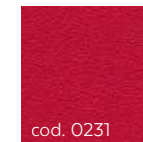

ROSSO
Red
0231

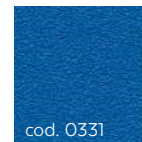

BLU
Blue
0331



CELESTE
Light blue
0379



VERDE ACIDO
Acid green
0426

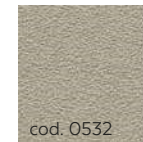

AVORIO
Ivory
0532



NOCCIOLA
Light brown
0534



GRIGIO PERLA
Light grey
0643



NERO
Black
0651

Oltre ai 10 colori standard dei tessuti della cartella colori ZEN, è disponibile una gamma estesa di colori con sovrapprezzo del 10% e con un minimo di ordine di 9 pannelli dello stesso tipo. Per il colore bianco il sovrapprezzo è del 20%. Inquadra il QR code per scaricare la cartella colori estesa ZEN. Per maggiori informazioni contattare il customer care a info@steelbox.it. In addition to the 10 standard colors of the ZEN fabric swatch, an extended range of colors is available with a 10% surcharge and a minimum order of 9 panels of the same type. For the color white, there is a 20% surcharge. Scan the QR code to download the extended ZEN color swatch. For more information contact the customer care office export@steelbox.it



SUPPORTI WALL / CEILING PER ZEN SQUARE

ZEN SQUARE WALL / CEILING SUPPORTS

CEILP645 per pannello dim. cm 59x59
CEILP645 for panel dim. cm 59x59



CEILP690 per pannello dim. cm 59x59
CEILP690 for panel dim. cm 59x59



CEILP045 per pannello dim. cm 118x118
CEILP045 for panel dim. cm 118x118



CEILP090 per pannello dim. cm 118x118
CEILP090 for panel dim. cm 118x118



CEIL2CONTORI per pannello dim. cm 59x59
CEIL2CONTORI for panel dim. cm 59x59



TELPA059 per pannello dim. cm 118x59
TELPA059 for panel dim. cm 118x59

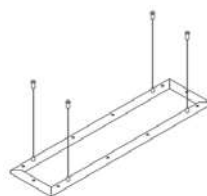

TELPA118 per pannello dim. cm 118x118
TELPA118 for panel dim. cm 118x118

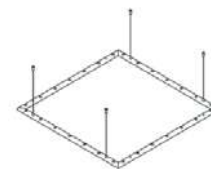

KITVELCR coppia adesivi con velcro cm Ø8,5
KITVELCR pair of stickers with velcro cm Ø8,5



KITVELFE coppia adesivi con velcro e piastrino
cm Ø8,5
KITVELFE pair of stickers with velcro and metal
plate cm Ø8,5

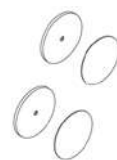

DESCRIZIONI TECNICHE

TECHNICAL FEATURES

ZEN SQUARE SUPPORTI

I supporti a muro e soffitto sono realizzati in lamiera d'acciaio 30/10 saldata e presso-piegata, verniciata con polveri epossidiche.

Accessori per l'installazione sospesa:

I telai per l'installazione sospesa dei pannelli mono facciali sono realizzati in tubolare di acciaio cm 3x1,5 di spessore 15/10 integrati con cavetti d'acciaio di 1mm di diametro con cavetti di acciaio cromato di prima qualità.

I cavetti per l'installazione sospesa senza telaio sono realizzati in acciaio cromato di prima qualità mentre i cavi di sostegno anch'essi in acciaio hanno un diametro di 1 mm.

I sistemi di installazione sospesa Zen sono certificati dall'Istituto Giordano a norma CE

Il kitvelfe include un piastrino in metallo di diametro cm 8 di spessore 20/10 è realizzato in lamiera d'acciaio verniciata con polveri epossidiche.

ZEN SQUARE SUPPORTS

The wall and ceiling supports are made by steel foil 30/10 welded and press formed, painted with epoxy resin powder.

Accessories for suspended installation:

The frames for suspending single-sided panels are constructed from 3x1.5 cm steel tubular with a thickness of 15/10, integrated with 1mm diameter steel cables coated with high-quality chrome-plated steel cables.

The cables for frameless suspended installation are made of high-quality chrome-plated steel, while the supporting cables, also made of steel, have a diameter of 1mm.

The Zen suspended installation systems are CE-certified by the Giordano Institute.

The kitvelfe includes a metal plate with a diameter of 8 cm and a thickness of 20/10, made of steel sheet painted with epoxy powders.

COLORI METALLI

METAL COLORS

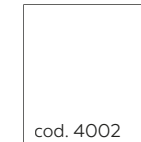

cod. 4002

BIANCO
White
RAL 9003



cod. 7035

GRIGIO CHIARO
Light grey
RAL 7035

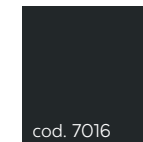

cod. 7016

ANTRACITE
Anthracite
RAL 7016

Altri colori RAL sono disponibili su richiesta con un sovrapprezzo del 10%

Other RAL colors are available on demand with 10% overprice

I codici colori dei metalli corrispondono alle codifiche RAL standard internazionali

The color codes of our metal match with International Standard RAL

ZEN Sphere

Una forma geometrica perfetta ed armoniosa, Zen Sphere si ispira alla bellezza del cerchio per creare simmetrie negli spazi e ottenere il comfort acustico desiderato. Tre dimensioni, 10 colori, una vasta scelta di supporti a muro e soffitto. Disponibile anche nella variante con lampada Led con diverse tonalità di luce.

A perfect and harmonious geometric shape, Zen Sphere is inspired by the beauty of the circle to create symmetries in spaces and obtain the desired acoustic comfort. Three sizes, 10 colors, a wide choice of wall and ceiling supports. Also available in the variant with LED lamp with different shades of light.



Scarica la brochure.
Download the leaflet.



Scarica il technical book.
Download the technical book.





Zen Sphere dim 60cm può essere utilizzato a parete con gli appositi telai con il kit di fissaggi costituito da cavi in acciaio per pannello.

Zen Sphere dim 60cm can be wall-mounted using the appropriate frames with the mounting kit consisting of steel cables.



Zen Sphere dim 90/120cm può essere utilizzato a parete con gli appositi telai con il kit di fissaggi costituito da cavi in acciaio per pannello.

Zen Sphere dim 90/120cm can be wall-mounted using the appropriate frames with the mounting kit consisting of steel cables.



Staffa a muro H 4,5 cm per pannello zen sphere cm D60
Wall support H 4,5 cm for zen sphere cm D60



Staffa a muro H 9 cm per pannello zen sphere cm D60
Wall support H 9 cm for zen sphere cm D60



I dischetti in Velcro sono utilizzabili su qualsiasi superficie liscia e sono adatti per un riposizionamento facile e veloce su pareti che non possono essere forate. Il Velcro è utilizzabile solo per i pannelli MONOFACCIALI.

The Velcro discs can be used on any smooth surface and are useful to ease the repositioning and to fix the panels on walls that cannot be drilled.

The Velcro can be used for ONE SIDE panels only.

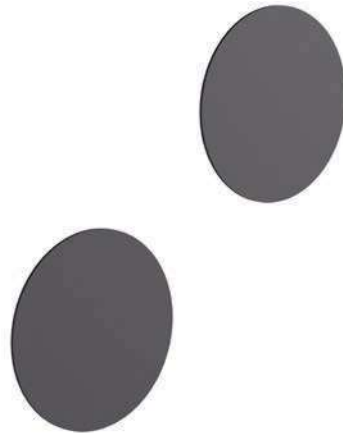

Coppia adesivi con velcro e piastrino in metallo per fissaggi su superfici ruvide. Dimensioni del velcro/piastrino cm Ø8,5.

Pair of stickers with velcro and metal plate for fixing on any rough surface. Dimension of the velcro/metal plate cm Ø8,5.





Il pannello monofacciale Zen Sphere può essere utilizzato in vari modi, a soffitto o parete attraverso dei supporti metallici, CEILB045 e CEILB090, e si può sovrapporre per ottenere un gradevole effetto ottico tridimensionale. Altri supporti quali, Magneti, Velcro e cavetti in acciaio, sono disponibili a catalogo, per ottenere un arredamento innovativo e flessibile.

The one-side Zen Sphere panel can be used with different fixings. If used with the CEILB045 and CEILB090 brackets, can be overlapped to obtain a nice three-dimensional optical effect. Other supports such as Magnets, Velcro, and steel cable Balancer, are available in the catalog, to get a fancy and flexible furnishing.

Pannello Acustico Zen Sphere cm Ø90 con lampada led: per luce colore 3000° K, 4000° K, 6000° K. e kit di fissaggi. Consumo nominale 24W
Acoustic Panel Zen Sphere cm ø90 with led lamp complete with mounting kit.
Nominal consumption 24W



Pannello Acustico Zen Sphere cm Ø120 con lampada led: per luce colore 3000° K, 4000° K, 6000° K. e kit di fissaggi. Consumo nominale 24W
Acoustic Panel Zen Sphere cm ø120 with led lamp complete with mounting kit.
Nominal consumption 24W



ZEN SPHERE PANEL

ZEN SPERE PANEL

Pannello Acustico Zen Sphere cm Ø60
Acoustic Panel Zen Sphere cm Ø60



Pannello Acustico Zen Sphere cm Ø90 con lampada led e kit di fissaggio
Acustic Panel Zen Sphere cm ø90 with led lamp complete with mounting kit



Pannello Acustico Zen Sphere cm Ø90
Acoustic Panel Zen Sphere cm Ø90



Pannello Acustico Zen Sphere cm Ø120 con lampada led e kit di fissaggio
Acustic Panel Zen Sphere cm ø120 with led lamp complete with mounting kit



Pannello Acustico Zen Sphere cm Ø120
Acoustic Panel Zen Sphere cm Ø120



DESCRIZIONI TECNICHE

TECHNICAL FEATURES

ZEN SPHERE PANEL

I pannelli monofacciali sono realizzati in fibra di poliestere riciclata, termoformata e tagliata a laser. La fibra è rivestita con tessuto bi-elastico stretch "TREVIRA CS" da un solo lato, senza l'inserto in honeycomb. Nel lato non a vista, il pannello è rivestito con telina nera adatta per il fissaggio a Velcro.

LAMPD090/120: Pannello zen sphere diametro cm 90/120 con lampada Led integrata, compresa di kit sospensione per soffitto con driver integrato per luce colore 3000° K , 4000° K, 6000° K , Ø 290mm, certificata CE e RoHs, driver a tensione costante certificato CE, SELV (Safety Extra Low Voltage), classe di isolamento II. Consumo nominale 24W e 2160lm.

Altre tipologie Kelvin disponibili su richiesta

CARATTERISTICHE DI RESISTENZA AL FUOCO DEL TESSUTO "TREVIRA CS"

Italia - Classe 1 / Germania - B1 DIN 4102 / Francia - M1 / Austria - B1 OENORM B3825 - Q1 OENORM 3800 Part. 1 - BS 5852 Crib 5 using a CM Foam 35 kg/cu.m - EN 1021 Part.1-2 using a CM Foam 35 kg/cu.m - USA Calif. Bull. 117 June 2013 - EN 13501 - 1,2 : B-s1, d0 - EN 13773 Burning Behaviour: class 1 - EN ISO 6940/6941 / Svizzera - Fire Protection Classification: 5.3

ZEN SPHERE PANEL

The one side panels are made by recycled polyester fiber, The edges of the panels are laser cut. Panels are upholstered with double stretch fabric "TREVIRA CS" on one side only and without the honeycomb insert. On the non-visible side, the panel is covered with a black cloth suitable for Velcro fastening.

LAMPD090/120: Zen sphere panel diameter 90/120 cm with integrated Led lamp, including ceiling suspension kit with integrated driver for 3000° K , 4000° K, 6000° K , Ø 290mm, CE and RoHs certified light color, CE and RoHs certified constant voltage driver, SELV (Safety Extra Low Voltage), insulation class II. Nominal consumption 24W and 2160lm.

Other Kelvin gradation available upon request

FIRE RETARDANT FABRIC FEATURES "TREVIRA CS"

Italy- Classe 1 / Germany- B1 DIN 4102 / France - M1 / Austria - B1 OENORM B3825 - Q1 OENORM 3800 Part. 1 - BS 5852 Crib 5 using a CM Foam 35 kg/cu.m - EN 1021 Part.1-2 using a CM Foam 35 kg/cu.m - USA Calif. Bull. 117 June 2013 - EN 13501 - 1,2 : B-s1, d0 - EN 13773 Burning Behaviour: class 1 - EN ISO 6940/6941 / Switzerland - Fire Protection Classification: 5.3

COLORI TESSUTO TREVIRA CS

FABRIC TREVIRA CS COLOR



cod. 0053

GIALLO
Yellow
0053

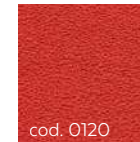

cod. 0120

ARANCIO
Orange
0120

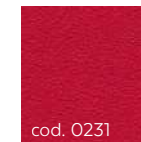

cod. 0231

ROSSO
Red
0231

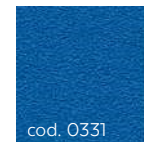

cod. 0331

BLU
Blue
0331



cod. 0379

CELESTE
Light blue
0379



cod. 0426

VERDE ACIDO
Acid green
0426

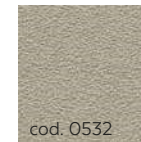

cod. 0532

AVORIO
Ivory
0532



cod. 0534

NOCCIOLA
Light brown
0534



cod. 0643

GRIGIO PERLA
Light grey
0643



cod. 0651

NERO
Black
0651

Oltre ai 10 colori standard dei tessuti della cartella colori ZEN, è disponibile una gamma estesa di colori con sovrapprezzo del 10% e con un minimo di ordine di 9 pannelli dello stesso tipo. Per il colore bianco il sovrapprezzo è del 20%. Inquadra il QR code per scaricare la cartella colori estesa ZEN. Per maggiori informazioni contattare il customer care a info@steelbox.it. In addition to the 10 standard colors of the ZEN fabric swatch, an extended range of colors is available with a 10% surcharge and a minimum order of 9 panels of the same type. For the color white, there is a 20% surcharge. Scan the QR code to download the extended ZEN color swatch. For more information contact the customer care office export@steelbox.it



SUPPORTI ZEN SPHERE

ZEN SPERE SUPPORTS

CEILP645 per pannello dim. cm 59x59
CEILP645 for panel dim. cm 59x59



CEILP690 per pannello dim. cm 59x59
CEILP690 for panel dim. cm 59x59



CEILP045 per pannello dim. cm 118x118
CEILP045 for panel dim. cm 118x118



CEILP090 per pannello dim. cm 118x118
CEILP090 for panel dim. cm 118x118



TELPD060 per pannello Ø60cm
TELPD060 for panel Ø60cm



TELPD120 per pannello Ø90/120cm
TELPD120 for panel Ø90/120 cm



KITVELCR coppia adesivi con velcro cm Ø8,5
KITVELCR pair of stickers with velcro cm Ø8,5



KITVELFE coppia adesivi con velcro e
piastrino cm Ø8,5
KITVELFE pair of stickers with velcro and
metal plate cm Ø8,5

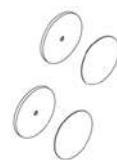

DESCRIZIONI TECNICHE

TECHNICAL FEATURES

ZEN SPHERE SUPPORTI

I supporti a muro e soffitto sono realizzati in lamiera d'acciaio 30/10 saldata e presso-piegata, verniciata con polveri epossidiche.

Accessori per l'installazione sospesa:

I telai per l'installazione sospesa dei pannelli mono facciali sono realizzati in tubolare di acciaio cm 3x1,5 di spessore 15/10 integrati con cavetti d'acciaio di 1mm di diametro con cavetti di acciaio cromato di prima qualità.

I cavetti per l'installazione sospesa senza telaio sono realizzati in acciaio cromato di prima qualità mentre i cavi di sostegno anch'essi in acciaio hanno un diametro di 1 mm.

I sistemi di installazione sospesa Zen sono certificati dall'Istituto Giordano a norma CE

LAMPD090/120: Pannello zen sphere diametro cm 90/120 con lampada Led integrata, compresa di kit sospensione per soffitto con driver integrato per luce colore 3000° K , 4000° K, 6000° K , Ø 290mm, certificata CE e RoHs, driver a tensione costante certificato CE, SELV (Safety Extra Low Voltage), classe di isolamento II. Consumo nominale 24W e 2160lm.

Il kitvelfe include un piastrino in metallo di diametro cm 8 di spessore 20/10 è realizzato in lamiera d'acciaio verniciata con polveri epossidiche.

ZEN SPHERE SUPPORTS

The wall and ceiling supports are made by steel foil 30/10 welded and press formed, painted with epoxy resin powder.

Accessories for suspended installation:

The frames for suspending single-sided panels are constructed from 3x1.5 cm steel tubular with a thickness of 15/10, integrated with 1mm diameter steel cables coated with high-quality chrome-plated steel cables.

The cables for frameless suspended installation are made of high-quality chrome-plated steel, while the supporting cables, also made of steel, have a diameter of 1mm.

The Zen suspended installation systems are CE-certified by the Giordano Institute.

LAMPD090/120: Zen sphere panel diameter 90/120 cm with integrated Led lamp, including ceiling suspension kit with integrated driver for 3000° K , 4000° K, 6000° K , Ø 290mm, CE and RoHs certified light color, CE and RoHs certified constant voltage driver, SELV (Safety Extra Low Voltage), insulation class II. Nominal consumption 24W and 2160lm.

The kitvelfe includes a metal plate with a diameter of 8 cm and a thickness of 20/10, made of steel sheet painted with epoxy powders.

COLORI METALLI

METAL COLORS

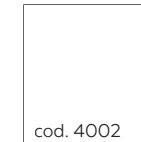

cod. 4002

BIANCO
White
RAL 9003



cod. 7035

GRIGIO CHIARO
Light grey
RAL 7035

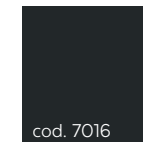

cod. 7016

ANTRACITE
Anthracite
RAL 7016

Altri colori RAL sono disponibili su richiesta con un sovrapprezzo del 10%

Other RAL colors are available on demand with 10% overprice

I codici colori dei metalli corrispondono alle codifiche RAL standard internazionali

The color codes of our metal match with International Standard RAL

Zen Soundshaper® con supporti ceiling

Zen Soundshaper® with ceiling supports

Da baffle acustici ai pannelli per controsoffitti, Zen Ceiling offre un'ampia gamma di supporti in diverse forme per soddisfare tutte le esigenze del mercato. L'ampia scelta di colori e materiali è in grado di adattarsi ad ogni bisogno acustico e decorativo per ogni ambiente. È adatto per palestre, stazioni radio, studi televisivi, uffici, scuole, biblioteche, centri culturali, auditorium, sale multifunzione, sale conferenze, sale da concerto e altri luoghi in cui sono necessari requisiti più elevati per la qualità dell'assorbimento acustico. La scelta di pannelli fonoassorbenti monofacciali e bifacciali consente di adeguare le esigenze a qualsiasi budget ed esigenza acustica.

From Acoustic baffles to false ceiling panels, Zen ceiling offers a wide range of supports in different shapes to satisfy all the needs in the market. The wide colors and materials selection can well meet the customers any acoustic and decorative requirement. It is suitable for gymnasium, radio station, television studio, offices, school, library, cultural center, auditorium, multi function hall, conference room, concert hall and other places where it's needed higher requirements for sound absorption quality. The choice of one side acoustic panels and double side acoustic panels allow to tune the requirements according to any budgets and sound absorption needs.



Scarica la brochure.
Download the leaflet.



Scarica il technical book.
Download the technical book.

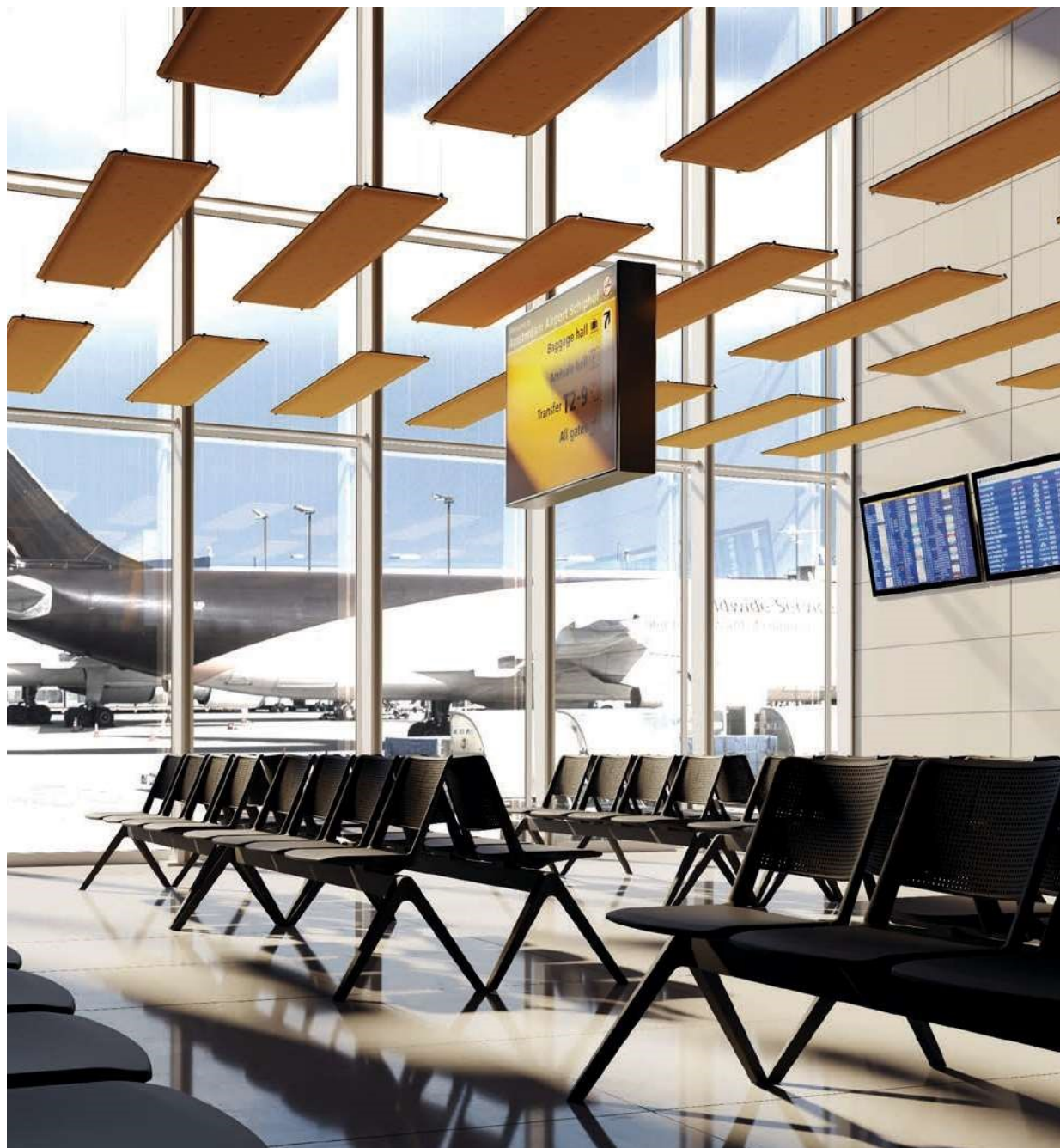

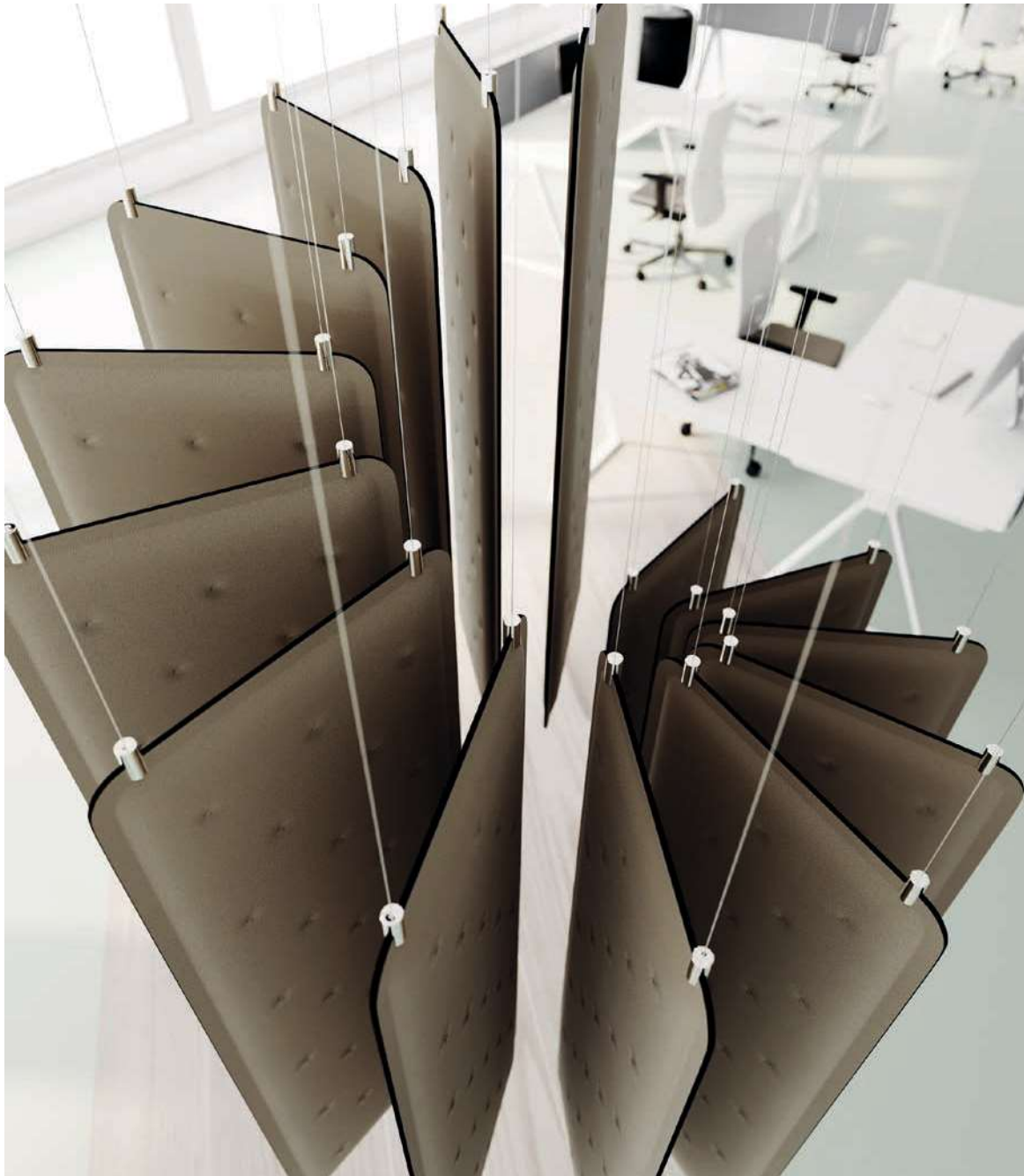



I differenti supporti per soffitto e controsoffitto offrono vantaggi di configurazioni verticali, orizzontali e combinate. Oggetti sospesi da un elegante cavetto in acciaio da 10/10, delicato ma resistente per tutti gli ambienti soprattutto quelli pubblici.

The different supports for the ceiling offer many advantages of configuration vertical, horizontal and combined. Suspended objects by an elegant tie rod of 10/10mm, heavy duty either refined for all the environments particularly public.

I pannelli Zen SoundShaper® di Steelbox sono caratterizzati da una tecnologia brevettata e sono certificati in Classe A nella frequenza del parlato, dalla ZetaLAB, laboratorio indipendente. Il pannello brevettato di Zen SoundShaper® è composto da due materassini di fibra di poliestere di spessore 30 mm e densità 1400kg/m³ che avvolgono un pannello alveolare ignifugo. I pannelli originali Zen SoundShaper® presentano delle piccole depressioni in superficie che ne migliorano le prestazioni acustiche.

Steelbox's Zen SoundShaper® panels are featured by patented technology and are certified Class A in speech frequency by ZetaLAB, an independent laboratory. The patented Zen SoundShaper® panel consists of two 30mm thick polyester fiber mats with a density of 1400kg/m³ wrapping around a fire-resistant honeycomb panel. Original Zen SoundShaper® panels feature small surface depressions that enhance their acoustic performance.

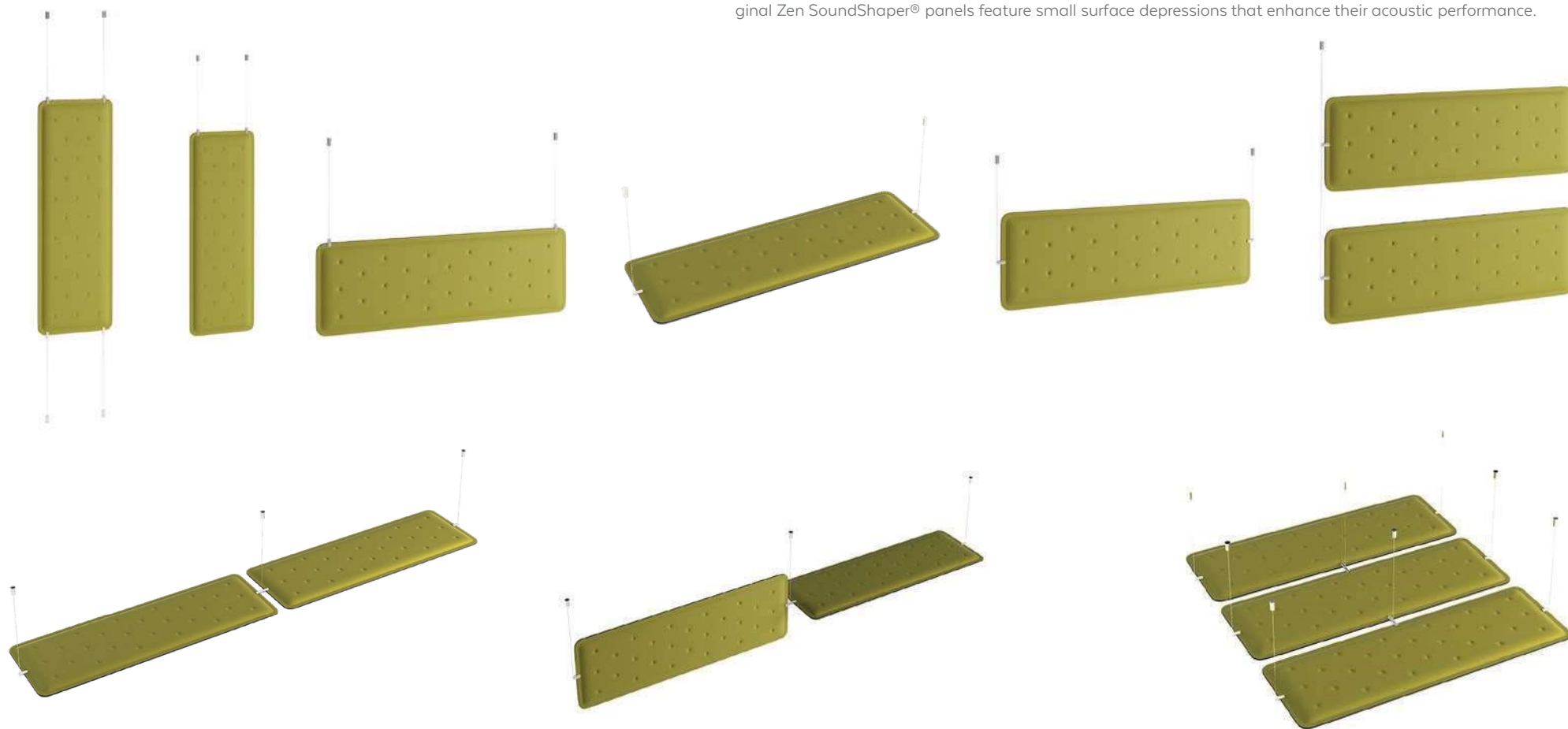



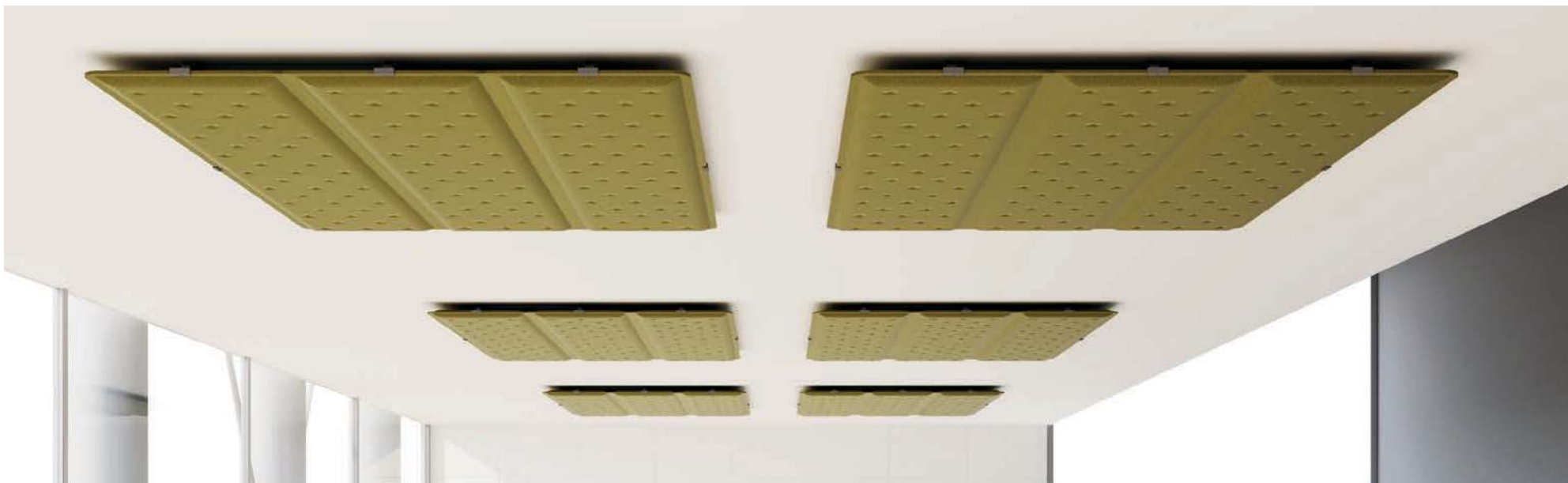

Staffa del Kit profilo montaggio muro e soffitto, consigliato per pannello fino cm L 100.

Bracket of the wall and ceiling mounting set, suggest for panels till cm W 100.



Staffa del kit montaggio muro e soffitto dei pannelli, consigliata nell'uso per pannelli oltre cm L 120

Bracket of the wall and ceiling mounting set, suggested to use for panels from cm W 120



Telaio per pannelli multipli.

Frame for multiple panels.









Pannello acustico Zen Soundshaper® con lampada led luce colore 3000k cm L140 compreso di kit di sospensione per soffitto. Consumo nominale 28W.

Acoustic Panel Zen Soundshaper® with led lamp light color 3000K cm 140 with suspending kit included. Nominal consumption 28w.



Pannello acustico Zen Soundshaper® con 2 faretto led luce colore 3000k cm 140 compreso di kit di sospensione per soffitto. Consumo nominale 12W.

Acoustic Panel Zen Soundshaper® with 2 led spots light color 3000K cm 140 with suspending kit included. Nominal consumption 12w

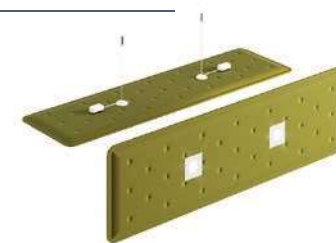

PANNELLI ACUSTICI BIFACCIALI ZEN SOUNDSHAPER®

DOUBLE SIDE ACOUSTIC PANELS ZEN SOUNDSHAPER®

Pannello Acustico Zen Soundshaper®
Acoustic Panel Zen Soundshaper®

Larghezze disponibili
Available widths
L/W 60 / 80 / 100 / 120 / 140 / 160 / 180 cm

Altezze disponibili
Available heights
H 40 cm

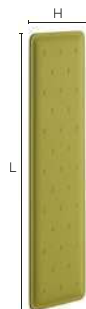

Pannello Acustico Zen Soundshaper® doppio
Acoustic Panel Zen Soundshaper® double

Larghezze disponibili
Available widths
L/W 60 / 80 / 100 / 120 / 140 / 160 / 180 Cm

Altezze disponibili
Available heights
H 80 Cm

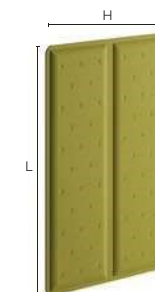

Pannello Acustico Zen Soundshaper®
Acoustic Panel Zen Soundshaper®

Larghezze disponibili
Available widths
L/W 60 / 80 / 100 / 120 / 140 / 160 / 180 Cm

Altezze disponibili
Available heights
H 60 cm

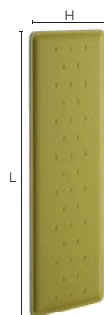

Pannello Acustico Zen Soundshaper® triplo
Acoustic Panel Zen Soundshaper® triple

Larghezze disponibili
Available widths
L/W 60 / 80 / 100 / 120 / 140 / 160 / 180 Cm

Altezze disponibili
Available heights
H 120 Cm

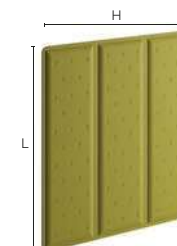

Pannello Acustico Zen Soundshaper® Con Lampada Led
Acoustic Panel Zen Soundshaper® with led lamp

L 140 x H 40 cm

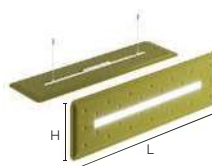

Pannello Acustico Zen Soundshaper® con 2 Faretto Led
Acoustic Panel Zen Soundshaper® with 2 led spots light

L 140 x H 40 cm

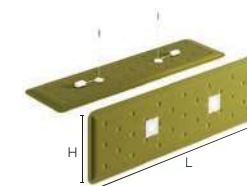

DESCRIZIONI TECNICHE

TECHNICAL FEATURES

ZEN SOUNDSHAPER® PANEL

Al prodotto è attribuita la classe di conformità alla UNI EN 13501:2009 in CLASSE DI REAZIONE AL FUOCO B-s2,d0 Classe 1 ITALIA

I pannelli bifacciali sono realizzati in fibra di poliestere riciclata termoformata con un inserto ignifugo honeycomb. Tecnologia brevettata Soundshaper®. I bordi sono tagliati a laser. I pannelli sono rivestiti con tessuto bi-elastico stretch "TREVIRA CS".

LAMPLLUN: Pannello da cm. 140 con lampada led compreso kit di sospensione a soffitto: Lampada da incasso per illuminazione diretta composta da profilato estruso in alluminio, cover in policarbonato opaco, strip LED 5050 luce naturale 4000° K certificata CE e RoHs, driver a tensione costante certificato CE, SELV (Safety Extra Low Voltage), classe di isolamento II. Consumo nominale 28W e 459lm.

LAMPLFAR: Pannello da cm. 140 con 2 mini led spots, CE and RoHs certifications, 2 CE certified electronic drivers, Class II insulation. Nominal power 12W.

CARATTERISTICHE DI RESISTENZA AL FUOCO DEL TESSUTO "TREVIRA CS"

Italia - Classe 1 / Germania - B1 DIN 4102 / Francia - M1 / Austria - B1 OENORM B3825 - Q1 OENORM 3800 Part. 1 - BS 5852 Crib 5 using a CM Foam 35 kg/cu.m - EN 1021 Part.1-2 using a CM Foam 35 kg/cu.m - USA Calif. Bull. 117 June 2013 - EN 13501 - 1,2 : B-s1, d0 - EN 13773 Burning Behaviour: class 1 - EN ISO 6940/6941 / Svizzera - Fire Protection Classification: 5.3

ZEN SOUNDSHAPER® PANEL

The product is assigned the conformity class to UNI EN 13501:2009 in FIRE REACTION CLASS B-s2, d0 Classe 1 ITALY

The double side panels are made with recycled polyester fiber, thermoformed, with internal fireproof honeycomb structure. Soundshaper® technology is patented. The edges of the panels are laser cut. Panels are upholstered with double stretch fabric "TREVIRA CS".

LAMPLLUN: 140 cm Panel with Led light and ceiling suspension kit: Direct illumination recessed lamp made of extruded aluminum body with matt polycarbonate cover, strip LED 5050, 4000° K natural light, CE and RoHs certifications, CE certified constant voltage electronic driver, Class II insulation. Nominal power 28W e 459lm.

LAMPLFAR: 140 cm Panel with 2 mini Led light spots and ceiling suspension kit. CE and RoHs certifications, 2 CE certified electronic drivers, Class II insulation. Nominal power 12W.

FIRE RETARDANT FABRIC FEATURES "TREVIRA CS"

Italy- Classe 1 / Germany- B1 DIN 4102 / France - M1 / Austria - B1 OENORM B3825 - Q1 OENORM 3800 Part. 1 - BS 5852 Crib 5 using a CM Foam 35 kg/cu.m - EN 1021 Part.1-2 using a CM Foam 35 kg/cu.m - USA Calif. Bull. 117 June 2013 - EN 13501 - 1,2 : B-s1 , d0 - EN 13773 Burning Behaviour: class 1 - EN ISO 6940/6941 / Switzerland - Fire Protection Classification: 5.3

COLORI TESSUTO TREVIRA CS

FABRIC TREVIRA CS COLOR

 cod. 0053	 cod. 0120	 cod. 0231	 cod. 0331
GIALLO Yellow 0053	ARANCIO Orange 0120	ROSSO Red 0231	BLU Blue 0331
 cod. 0379	 cod. 0426	 cod. 0532	 cod. 0534
CELESTE Light blue 0379	VERDE ACIDO Acid green 0426	AVORIO Ivory 0532	NOCCIOLA Light brown 0534
 cod. 0643	 cod. 0651		
GRIGIO PERLA Light grey 0643	NERO Black 0651		

Oltre ai 10 colori standard dei tessuti della cartella colori ZEN, è disponibile una gamma estesa di colori con sovrapprezzo del 10% e con un minimo di ordine di 9 pannelli dello stesso tipo. Per il colore bianco il sovrapprezzo è del 20%. Inquadra il QR code per scaricare la cartella colori estesa ZEN. Per maggiori informazioni contattare il customer care a info@steelbox.it. In addition to the 10 standard colors of the ZEN fabric swatch, an extended range of colors is available with a 10% surcharge and a minimum order of 9 panels of the same type. For the color white, there is a 20% surcharge. Scan the QR code to download the extended ZEN color swatch. For more information contact the customer care office export@steelbox.it



Scarica
i colori tessuti.

Download
the fabric colors.

SOFFITTO CEILING

Staffa per montaggio a muro e soffitto per pannelli corti.
Wall and ceiling mounting bracket for short panels.



Staffa soffitto per pannelli singoli cm 60/80 posizionati in longitudinale e verticale.
Ceiling bracket for single panels cm 60/80 positioned longitudinally and vertically.

H 9 cm



Staffa soffitto per pannelli singoli cm 60/80 posizionati in longitudinale e verticale.
Ceiling bracket for single panels cm 60/80 positioned longitudinally and vertically.

H 4,5 cm



Staffa inclinata (30°) a soffitto per pannelli singoli cm 60/80/100 posizionati in longitudinale.
Inclined (30°) ceiling bracket for single panels cm 60/80/100 positioned longitudinally.

H 9 cm



SOFFITTO

CEILING

Staffa kit profilo montaggio muro/soffitto
Wall/ceiling mounting bracket



Coppia distanziali per supporti ceiling
Pair of spacers for ceiling brackets



H. 20 cm

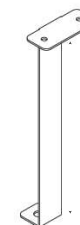

Staffa kit profilo montaggio muro/soffitto per pannelli H60
Wall/ceiling mounting bracket for H 60 panels



Staffa telaio per pannello multiplo doppio per muro/soffitto
Frame bracket for double panel for wall/ceiling mounting

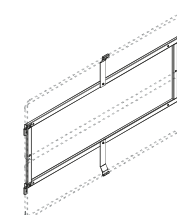

Staffa kit profilo montaggio muro/soffitto a croce
Wall/ceiling mounting cross bracket



Staffa telaio per pannello multiplo triplo per muro/soffitto
Frame bracket for triple panel for wall/ceiling mounting

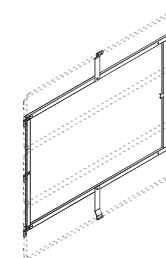

SOFFITTO

CEILING

Kit fissaggio laterale per pannelli posizionati in longitudinale singoli e multipli

Side mounting kit for single and multiple panels positioned in longitudinal

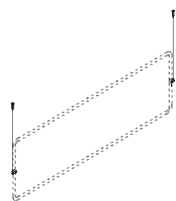

Kit fissaggio per pannello singolo posizionato in longitudinale e verticale

Mounting kit for single panel positioned in longitudinal and vertical

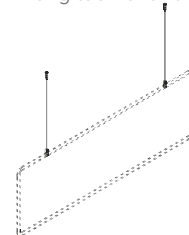

Morsetto per aggancio pannello singolo in verticale e longitudinale
Clamp for single panel in vertical and longitudinal



kit fissaggio laterale per pannello singolo posizionato in orizzontale
Side mounting kit for single panel positioned in horizontal

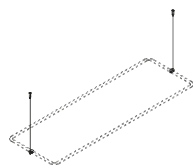

Morsetto da aggancio dall'alto laterale verticale.
Clamp coupling on vertical sides from above.



Coppia connettori per pavimento
Set of connectors to floor



kit connettore doppio orientabile
Set of swiveling double connector

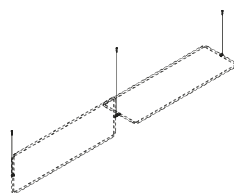

Morsetto per aggancio pannello laterale orizzontale
Clamp for lateral fixing of panel in horizontal



Connettore centrale doppio orientabile
swiveling double connector



DESCRIZIONI TECNICHE

TECHNICAL FEATURES

ZEN SOUNDSHAPER® SUPPORTI CEILING

Supporti a muro/soffitto:

Supporti a staffa e croce: sono realizzati con acciaio tubolare tagliato al laser verniciato con polveri epossidiche e dotati di appositi agganci in lamiera saldati alle estremità e in lamiera d'acciaio 10/10 presso-piegata verniciata con polveri epossidiche. Supporti CEILP/WALLSTAW/CEILB: sono realizzati con lamiera d'acciaio di 30/10 tagliata a laser e verniciata con polveri epossidiche

Supporto CEILDIST: realizzato in lamiera di acciaio da 10/10 tagliata al laser, presso-piegata e verniciata con polveri epossidiche.

Gli accessori per l'installazione sospesa sono realizzati in acciaio cromato di prima qualità mentre i cavi di sostegno anch'essi in acciaio hanno un diametro di 1 mm.

Accessori per l'installazione sospesa:

I morsetti per l'installazione sospesa senza telaio sono realizzati in acciaio cromato di prima qualità mentre i cavi di sostegno anch'essi in acciaio hanno un diametro di 1 mm.

I sistemi di installazione sospesa Zen sono certificati dall'Istituto Giordano a norma CE

ZEN SOUNDSHAPER® CEILING SUPPORTS

Wall and ceiling supports:

Bracket and cross support: made from laser-cut tubular steel coated with epoxy powders, featuring specially welded sheet metal hooks at the ends and 10/10 gauge steel sheet, powder-coated and press-folded.

CEILP/WALLSTAW/CEILB supports: made from 30/10-gauge steel sheet cut with laser and coated with epoxy powders.

CEILDIST support: made from 10/10 gauge steel sheet, laser-cut, press-folded, and coated with epoxy powders.

Suspended ceiling accessories are made by first grade polished steel, the steel support cables have a diameter of 1 mm.

Accessories for suspended installation:

The clamps for frameless suspended installation are made of high-quality chrome-plated steel, while the supporting cables, also made of steel, have a diameter of 1mm.

The Zen suspended installation systems are CE-certified by the Giordano Institute.

COLORI METALLI

METAL COLORS

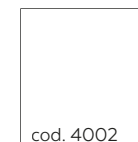

cod. 4002

BIANCO
White
RAL 9003

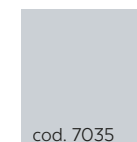

cod. 7035

GRIGIO CHIARO
Light grey
RAL 7035

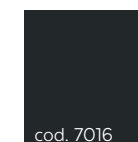

cod. 7016

ANTRACITE
Anthracite
RAL 7016

Altri colori RAL sono disponibili su richiesta con un sovrapprezzo del 10%

Other RAL colors are available on demand with 10% overprice

I codici colori dei metalli corrispondono alle codifiche RAL standard internazionali

The color codes of our metal match with International Standard RAL

Zen Soundshaper® con supporti wall

Zen Soundshaper® with wall supports

Il posizionamento di pannelli acustici sulle pareti è solitamente l'applicazione più comune per i pannelli acustici. Zen Wall, oltre ai supporti in metallo offre soluzioni in Velcro e Magneti per creare ambienti facilmente rinnovabili grazie ad un veloce riposizionamento e fissaggio. Zen Wall include una serie di supporti di diversa lunghezza per creare effetti tridimensionali mescolando diverse tonalità di colori simili.

The most common application for acoustic panels is typically wall mounting. In addition to metal supports, Zen Wall also provides Velcro and Magnetic solutions for easily reconfigurable environments through quick repositioning and fixation. Zen Wall offers a range of supports of varying lengths to create three-dimensional effects by mixing different shades of similar colors.



Scarica la brochure.
Download the leaflet.



Scarica il technical book.
Download the technical book.













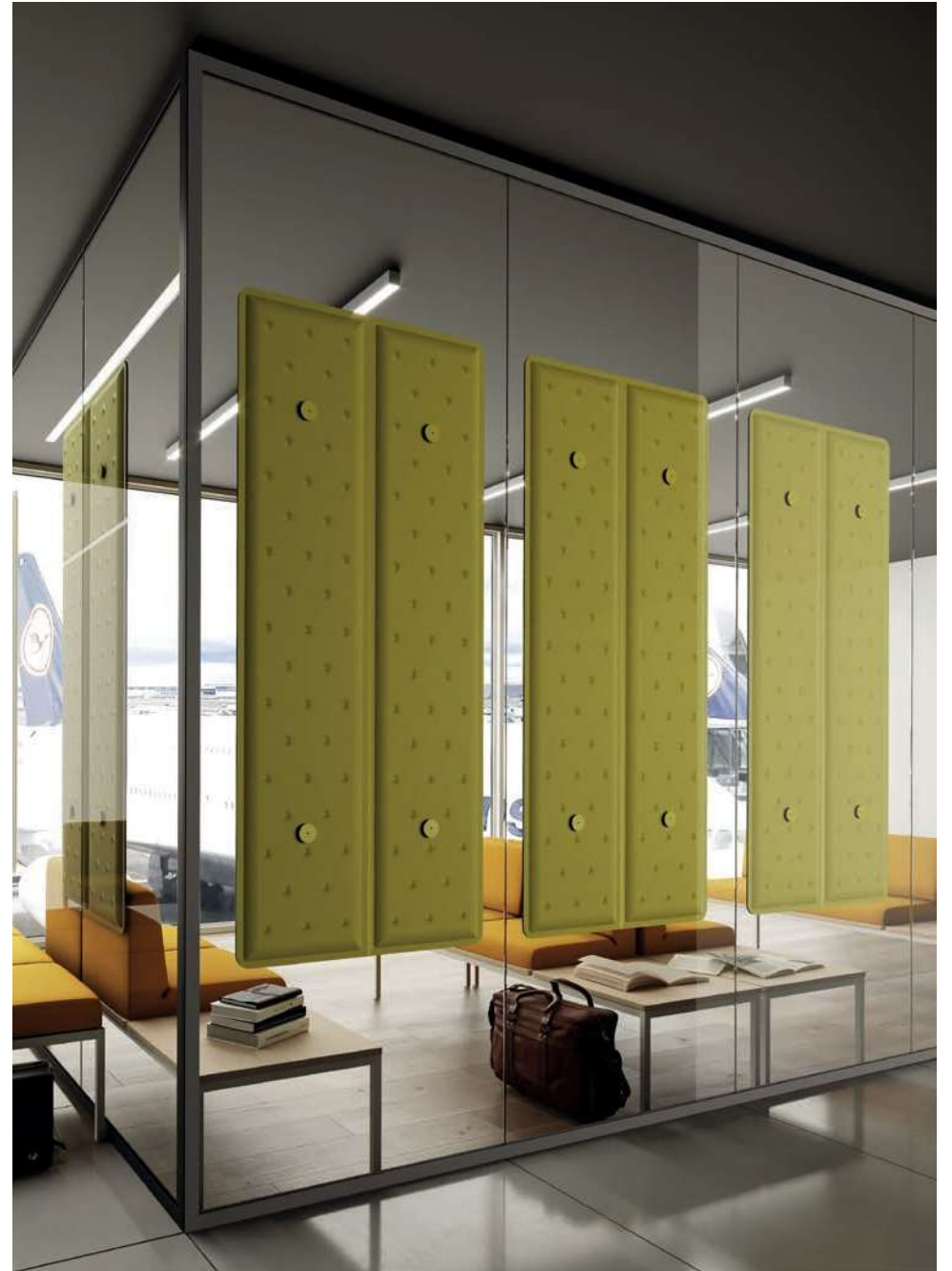

Kit 2 magneti ø cm 36 compresi di piastrino e feltrino.
Kit 2 magnets ø cm 36 including plate and felt.

Adesivo
sticker



Piastrino a colore del pannello.
Metal plate with same color of the panel.



ZEN WALL CEILING PANELS

Pannelli acustici bifacciali zen soundshaper®
Double side acoustic panels ZEN Soundshaper®

H 40 / 60 / 80 / 120 cm

L 60 / 80 / 100 / 120 / 140 / 160 / 180



Ataffe kit profilo montaggio muro/soffitto
Wall/ceiling mounting bracket





PANNELLI ACUSTICI BIFACCIALI ZEN SOUNDSHAPER®

DOUBLE SIDE ACOUSTIC PANELS ZEN SOUNDSHAPER®

Pannello Acustico Zen Soundshaper®
Acoustic Panel Zen Soundshaper®

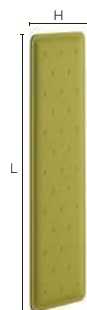

Larghezze disponibili
Available widths
L/W 60 / 80 / 100 / 120 / 140 / 160 / 180 Cm

Altezze disponibili
Available heights
H 40 Cm

Pannello Acustico Zen
Soundshaper® doppio
Acoustic Panel Zen
Soundshaper® double



Larghezze disponibili
Available widths
L/W 60 / 80 / 100 / 120 / 140 / 160 / 180 Cm

Altezze disponibili
Available heights
H 80 Cm

Pannello Acustico Zen Soundshaper®
Acoustic Panel Zen Soundshaper®

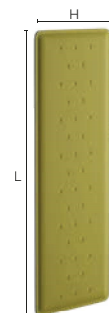

Larghezze disponibili
Available widths
L/W 60 / 80 / 100 / 120 / 140 / 160 / 180 Cm

Altezze disponibili
Available heights
H 60 Cm

Pannello Acustico Zen
Soundshaper® triplo
Acoustic Panel Zen
Soundshaper® triple

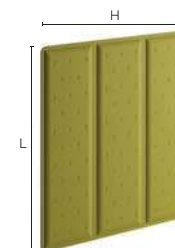

Larghezze disponibili
Available widths
L/W 60 / 80 / 100 / 120 / 140 / 160 / 180 Cm

Altezze disponibili
Available heights
H 120 Cm

DESCRIZIONI TECNICHE

TECHNICAL FEATURES

PANNELLI ZEN SOUNDSHAPER®

Al prodotto è attribuita la classe di conformità alla UNI EN 13501:2009 in CLASSE DI REAZIONE AL FUOCO B-s2,d0 Classe 1 ITALIA

I pannelli bifacciali sono realizzati in fibra di poliestere riciclata termoformata con un inserto ignifugo honeycomb. Tecnologia brevettata Soundshaper®. I bordi sono tagliati a laser. I pannelli sono rivestiti con tessuto bi-elastico stretch "TREVIRA CS".

CARATTERISTICHE DI RESISTENZA AL FUOCO DEL TESSUTO "TREVIRA CS"

Italia - Classe 1 / Germania - B1 DIN 4102 / Francia - M1 / Austria - B1 OENORM B3825 - Q1 OENORM 3800 Part. 1 - BS 5852 Crib 5 using a CM Foam 35 kg/cu.m - EN 1021 Part.1-2 using a CM Foam 35 kg/cu.m - USA Calif. Bull. 117 June 2013 - EN 13501 - 1,1,2 : B-s1, d0 - EN 13773 Burning Behaviour: class 1 - EN ISO 6940/6941 / Svizzera - Fire Protection Classification: 5,3

ZEN SOUNDSHAPER® PANELS

The product is assigned the conformity class to UNI EN 13501-1:2009 in FIRE REACTION CLASS B-s2, d0 Classe 1 ITALY

The double side panels are made with recycled polyester fiber, thermoformed, with internal fireproof honeycomb structure. Soundshaper® technology is patented. The edges of the panels are laser cut. Panels are upholstered with double stretch fabric "TREVIRA CS".

FIRE RETARDANT FABRIC FEATURES "TREVIRA CS"

Italy- Classe 1 / Germany- B1 DIN 4102 / France - M1 / Austria - B1 OENORM B3825 - Q1 OENORM 3800 Part. 1 - BS 5852 Crib 5 using a CM Foam 35 kg/cu.m - EN 1021 Part.1-2 using a CM Foam 35 kg/cu.m - USA Calif. Bull. 117 June 2013 - EN 13501 - 1,1,2 : B-s1 , d0 - EN 13773 Burning Behaviour: class 1 - EN ISO 6940/6941 / Switzerland - Fire Protection Classification: 5,3

COLORI TESSUTO TREVIRA CS

FABRIC TREVIRA CS COLOR

 cod. 0053	 cod. 0120	 cod. 0231	 cod. 0331
GIALLO Yellow 0053	ARANCIO Orange 0120	ROSSO Red 0231	BLU Blue 0331
 cod. 0379	 cod. 0426	 cod. 0532	 cod. 0534
CELESTE Light blue 0379	VERDE ACIDO Acid green 0426	AVORIO Ivory 0532	NOCCIOLA Light brown 0534
 cod. 0643	 cod. 0651		
GRIGIO PERLA Light grey 0643	NERO Black 0651		

Oltre ai 10 colori standard dei tessuti della cartella colori ZEN, è disponibile una gamma estesa di colori con sovrapprezzo del 10% e con un minimo di ordine di 9 pannelli dello stesso tipo. Per il colore bianco il sovrapprezzo è del 20%. Inquadra il QR code per scaricare la cartella colori estesa ZEN. Per maggiori informazioni contattare il customer care a info@steelbox.it. In addition to the 10 standard colors of the ZEN fabric swatch, an extended range of colors is available with a 10% surcharge and a minimum order of 9 panels of the same type. For the color white, there is a 20% surcharge. Scan the QR code to download the extended ZEN color swatch. For more information contact the customer care office export@steelbox.it



MURO / SOFFITTO

WALL / CEILING

Staffa per montaggio a muro e soffitto per pannelli corti.
Wall and ceiling mounting bracket for short panels.



Staffa telaio per pannello multiplo doppio per muro/soffitto.
Frame bracket for double panel for wall/ceiling mounting.

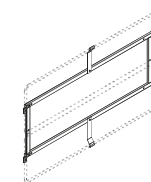

Staffa kit profilo montaggio muro/soffitto.
Wall/ceiling mounting bracket.



Staffa telaio per pannello multiplo triplo per muro/soffitto.
Frame bracket for triple panel for wall/ceiling mounting.

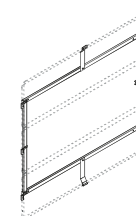

Staffa kit profilo montaggio muro/soffitto per pannelli H60.
Wall/ceiling mounting bracket for H 60 panels.



Supporti magnetici per superfici vetrate
Magnets supports for glass surfaces

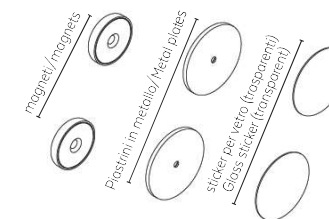

Kit 2 magneti \varnothing cm. 3,6 compresi di piastrino e feltrino per superfici in vetro.
Kit 2 magnets \varnothing cm 3, 6 including plate and felt for crystal.

Staffa kit profilo montaggio muro/soffitto a croce.
Wall/ceiling mounting cross bracket.



DESCRIZIONI TECNICHE

TECHNICAL FEATURES

ZEN SOUNDSHAPER® CON SUPPORTI WALL

Supporti a muro/soffitto:

Supporti a staffa e croce: sono realizzati con acciaio tubolare tagliato al laser verniciato con polveri epossidiche e dotati di appositi agganci in lamiera saldati alle estremità e in lamiera d'acciaio 10/10 presso-piegata verniciate con polveri epossidiche.

Supporti CEILP/WALLSTAW/CEILB: sono realizzati con lamiera d'acciaio di 30/10 tagliata a laser e verniciate con polveri epossidiche

Supporto CEILDIST: realizzato in lamiera di acciaio da 10/10 tagliata al laser, presso-piegata e verniciata con polveri epossidiche.

Supporti magnetici: magnete neodimio Ø 3,6 con foro svasato - forza attrazione 36 kg - finitura nichel, dischetto in metallo con adesivo.

ZEN SOUNDSHAPER® WITH WALL SUPPORTS

Wall and ceiling supports:

Bracket and cross support: made from laser-cut tubular steel coated with epoxy powders, featuring specially welded sheet metal hooks at the ends and 10/10 gauge steel sheet, powder-coated and press-folded.

CEILP/WALLSTAW/CEILB supports: made from 30/10-gauge steel sheet cut with laser and coated with epoxy powders.

CEILDIST support: made from 10/10 gauge steel sheet, laser-cut, press-folded, and coated with epoxy powders.

Magnets support: Neodymium magnet Ø 3.6 with countersunk hole - attraction force 36 kg - nickel finish - adhesive metal disc. They are made of top quality chromed steel.

COLORI METALLI

METAL COLORS

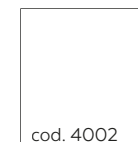

cod. 4002

BIANCO
White
RAL 9003

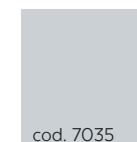

cod. 7035

GRIGIO CHIARO
Light grey
RAL 7035

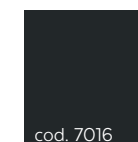

cod. 7016

ANTRACITE
Anthracite
RAL 7016

Altri colori RAL sono disponibili su richiesta con un sovrapprezzo del 10%

Other RAL colors are available on demand with 10% overprice

I codici colori dei metalli corrispondono alle codifiche RAL standard internazionali

The color codes of our metal match with International Standard RAL

ZEN Tangram

Ispirato al puzzle Tangram, che ebbe origine in Cina imperiale durante la dinastia Tang nel 618 AC e arrivato in Europa nel 19° secolo su navi mercantili. Il gioco era popolare durante la Prima Guerra Mondiale ed è diventato il puzzle più comune nel mondo. Modelli Tangram sono chiamati in Cina "Chin-Chiao Pan" che significa "Il puzzle coinvolgente dai 7 pezzi". È possibile avere più di 6500 differenti figure mescolando i 7 pezzi. Una tecnica per insegnare la matematica che è ancora applicata nelle aule di oggi. La stessa intuizione ha portato l'architetto Roberto Molteni a creare un oggetto fonoassorbente per migliorare l'acustica in ambienti pubblici e privati. Con Tangram è possibile creare più di 6500 forme da appendere alle pareti ed è facile, pronto per l'uso e adattabile a tutti gli ambienti come ad esempio, l'ufficio, la casa, camere per bambini, scuole, asili, home theater, sala riunioni, home office, e molto altro.

Inspired by the Tangram puzzles, originated in Imperial China during the Tang Dynasty in the 618 BC, and arrived to Europe in the 19th century on trading ships. The game was popular during the WWI and has become the most common dissection puzzle in the world. Tangram patterns are called in China "Chin-Chiao Pan" meaning intriguing seven piece puzzle. It's possible to have more than 6500 different figures mixing the 7 pieces. A technique to teach math that is still applied in classrooms today. The same intuition led architect Roberto Molteni to create a soundproof object to improve the sound management in public and private environments. With tangram is possible to create more than 6500 shapes to hang on the wall and it's easy, ready-to-use and adaptable to all the environment like for example office, home, kids rooms, schools, nursery schools, home theater environment, meeting room, home office, and much much more.



Scarica la brochure.
Download the leaflet.



Scarica il technical book.
Download the technical book.



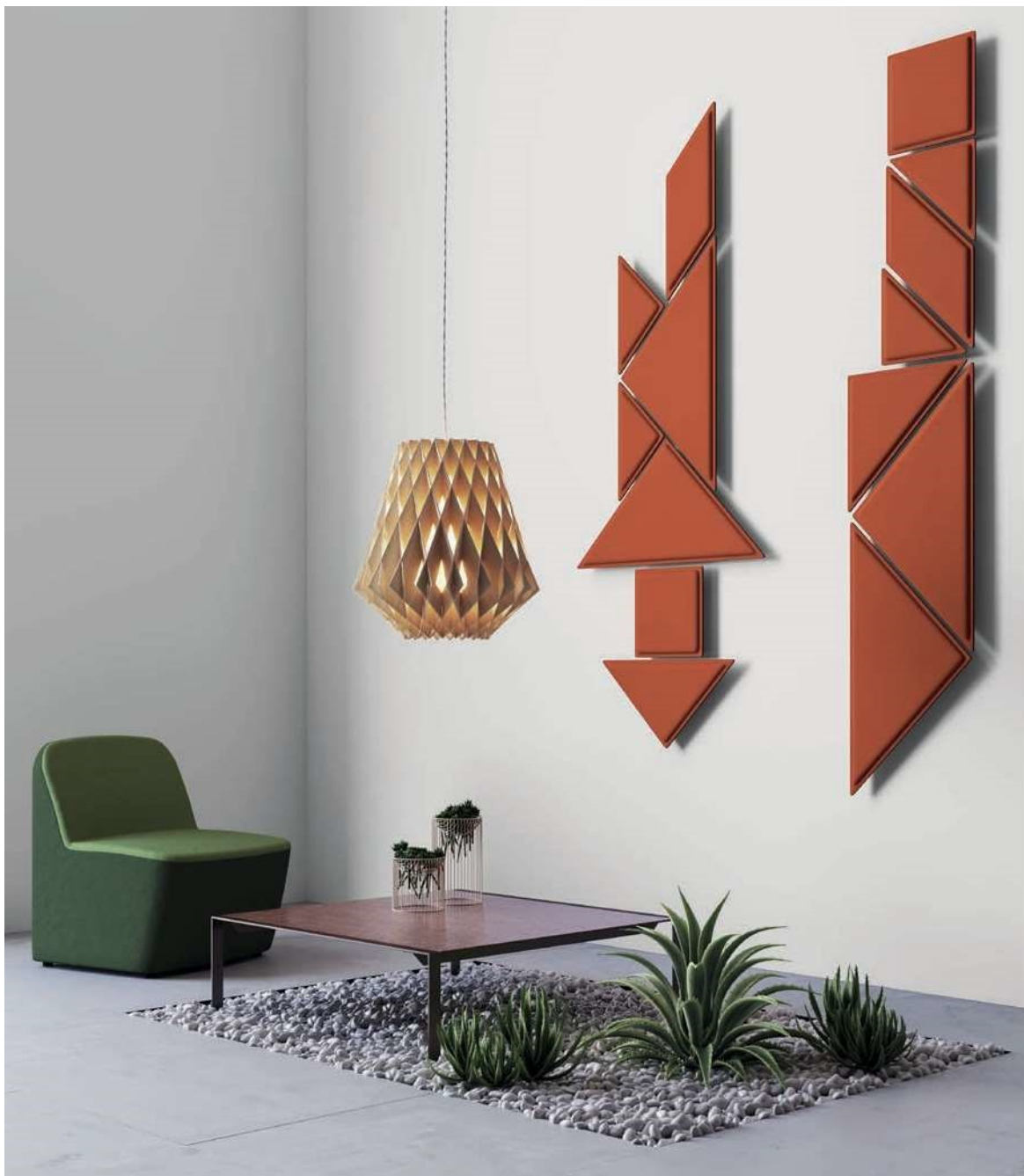

















PERSONE
PEOPLE
GENS
PERSONAS

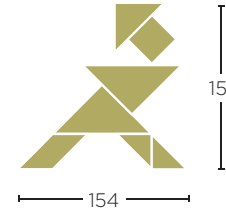
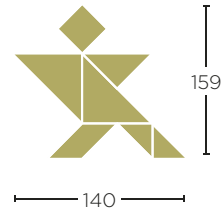
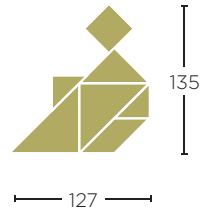

TRASPORTI
TRANSPORTATION
TRANSPORT
TRANSPORTES

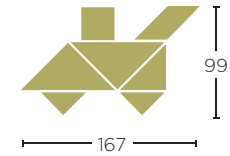
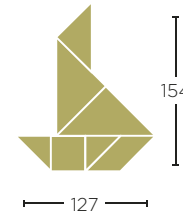
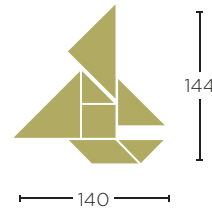
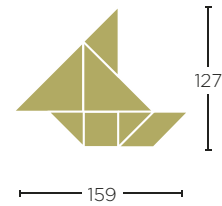

ANIMALI
ANIMALS
ANIMAUX
ANIMALES

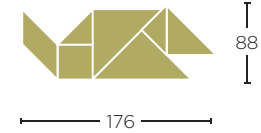
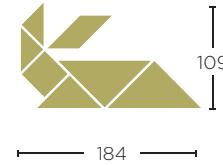
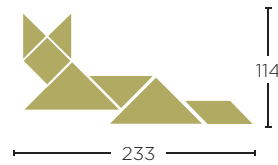

Dimensioni in cm
Dimensions in cm
Dimensions en cm
Dimensiones en cm

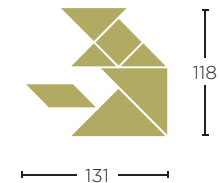
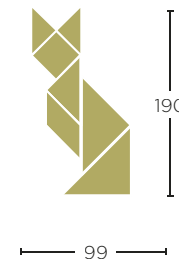
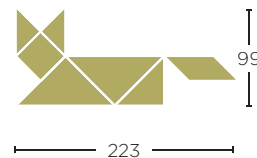
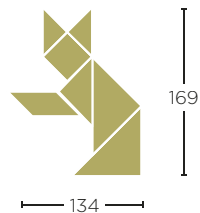

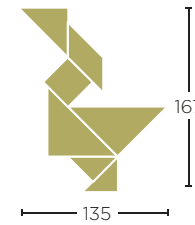
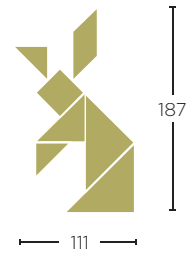
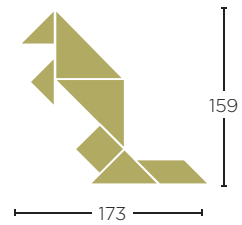
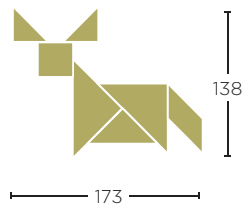
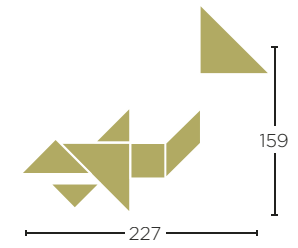
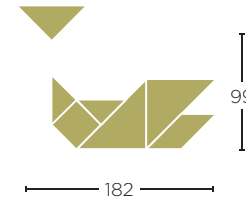
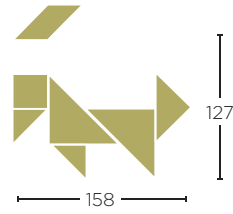
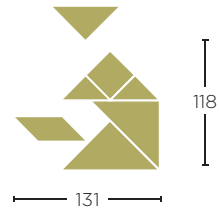
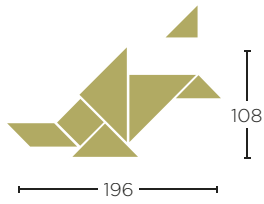
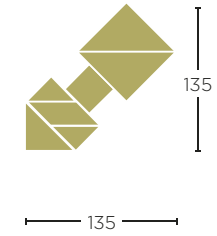
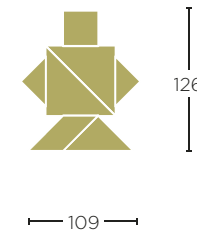
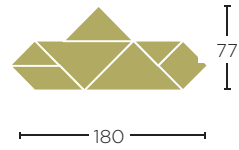
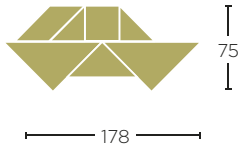
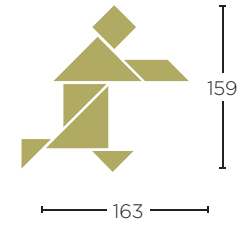
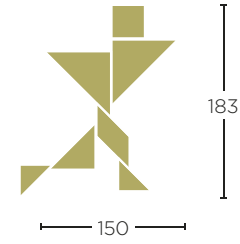
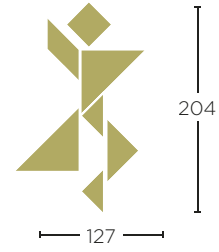
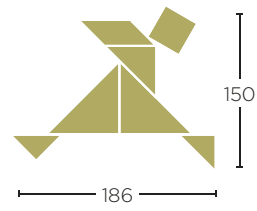
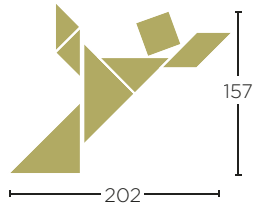

PANNELLO MONOFACCIALE TANGRAM CON SUPPORTI

ONE SIDE PANEL TANGRAM WITH SUPPORTS

Nell'imballo ci sono 7 pannelli, 7 staffe di fissaggio, dime di foratura, velcro e libretto di istruzioni per il montaggio con esempi di alcune figure - le viti non sono incluse.

In the packaging there are 7 panels, 7 wall mounting brackets, drilling template, velcro and instruction booklet with examples of possible shapes - the screws are not included.

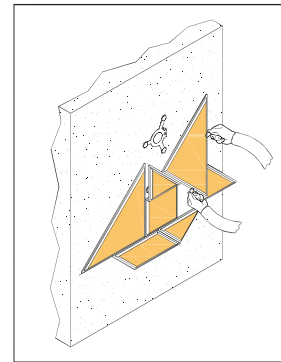
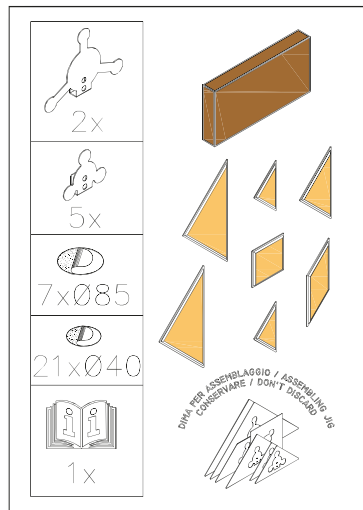

Il pannello si aggancia alla staffa tramite velcro.
The panel is fixed to the bracket by velcro.

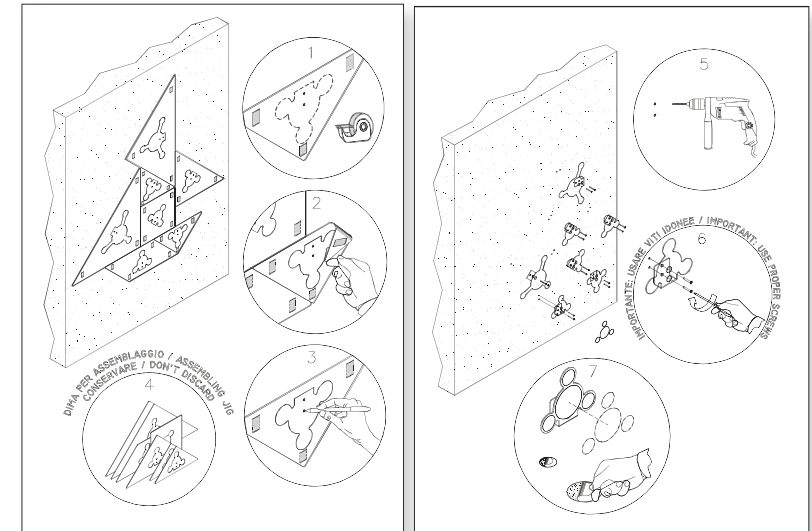

Dima di foratura per le prove di fissaggio a muro.
Drilling template for wall mounting tests.

Mescolando i 7 pannelli si possono ottenere fino a 6500 forme diverse.
Mixing the 7 panels you can get 6500 different shapes.



Tangram completo di staffe
Tangram with wall mounting brackets



Staffa di fissaggio in acciaio da 2,5 mm.
Wall bracket in steel of 2,5mm.



Spigoli arrotondati per uso in ambienti
per bambini.
Round corners to be used in children
environment.



PANNELLO MONOFACCIALE TANGRAM

ONE SIDE PANEL TANGRAM

Il Tangram senza staffe puo essere utilizzato con diversi fissaggi. Se utilizzato con le staffe CEILB045 e CEILB090 e si possono sovrapporre per ottenere un gradevole effetto ottico tridimensionale.

Tangram without brackets can be used with different fixings. If used with the CEILB045 and CEILB090 brackets, they can be overlapped to obtain a nice three-dimensional optical effect.



Staffa soffitto e muro cm h 4,5 per pannelli singoli posizionati in orizzontale
Ceiling and wall bracket cm h 4,5 for single panels positioned horizontally



Staffa soffitto e muro cm h 9 per pannelli singoli posizionati in orizzontale
Ceiling and wall bracket cm h 9 for single panels positioned horizontally

Su particolari superfici come acciaio, vetro o laminato si possono utilizzare dei dischetti in velcro per il fissaggio. Si possono ottenere molti design utilizzando i vari pannelli del tangram.

On particular surfaces such as steel, glass or laminates, Velcro discs can be used for fixing. Many different designs can be achieved by using Tangram panels.

I dischetti in Velcro sono utilizzabili su qualsiasi superficie liscia e sono utili per una facilità di riposizionamento su pareti che non possono essere forate.

The Velcro discs can be used on any smooth surface and are useful to ease the repositioning and to fix the panels on walls that cannot be drilled.

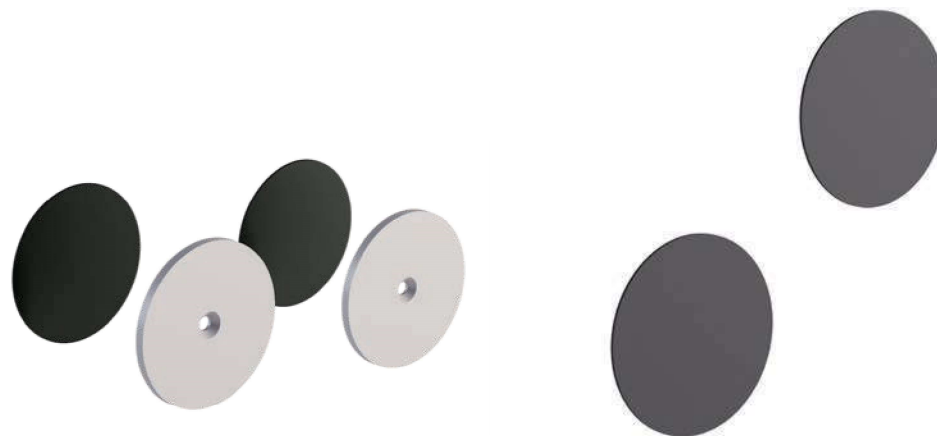

Coppia adesivi con velcro e piastrino in metallo per fissaggi su superfici ruvide
Pair of stickers with velcro and metal plate for fixing on any rough surface

cm Ø 8,5

Coppia adesivi con velcro per fissaggio su vetro, metallo e superfici lisce
Pair of stickers with velcro for fixing on glass, metal and smooth surfaces

cm Ø 8,5



Tangram senza staffe
Tangram without brackets

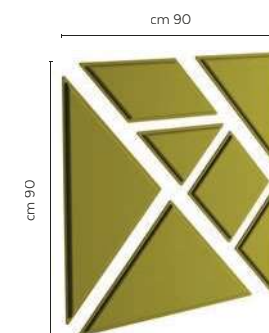



DESCRIZIONI TECNICHE

TECHNICAL FEATURES

TANGRAM PANEL

I pannelli monofacciali sono realizzati in fibra di poliestere riciclata, termoformata e tagliata a laser. La fibra è rivestita con tessuto bi-elastico stretch "TREVIRA CS" da un solo lato, senza l'inserto in honeycomb. Nel lato non a vista, il pannello è rivestito con telina nera adatta per il fissaggio a Velcro.

CARATTERISTICHE DI RESISTENZA AL FUOCO DEL TESSUTO "TREVIRA CS"

Italia - Classe 1 / Germania - B1 DIN 4102 / Francia - M1 / Austria - B1 OENORM B3825 - Q1 OENORM 3800 Part. 1 - BS 5852 Crib 5 using a CM Foam 35 kg/cu.m - EN 1021 Part.1-2 using a CM Foam 35 kg/cu.m - USA Calif. Bull. 117 June 2013 - EN 13501 - 1,2 : B-s1, d0 - EN 13773 Burning Behaviour: class 1 - EN ISO 6940/6941 / Svizzera - Fire Protection Classification: 5.3

TANGRAM PANEL

The one side panels are made by recycled polyester fiber, The edges of the panels are laser cut. Panels are upholstered with double stretch fabric "TREVIRA CS" on one side only and without the honeycomb insert. On the non-visible side, the panel is covered with a black cloth suitable for Velcro fastening.

FIRE RETARDANT FABRIC FEATURES "TREVIRA CS"

Italy- Classe 1 / Germany- B1 DIN 4102 / France - M1 / Austria - B1 OENORM B3825 - Q1 OENORM 3800 Part. 1 - BS 5852 Crib 5 using a CM Foam 35 kg/cu.m - EN 1021 Part.1-2 using a CM Foam 35 kg/cu.m - USA Calif. Bull. 117 June 2013 - EN 13501 - 1,2 : B-s1, d0 - EN 13773 Burning Behaviour: class 1 - EN ISO 6940/6941 / Switzerland - Fire Protection Classification: 5.3

COLORI TESSUTO TREVIRA CS

FABRIC TREVIRA CS COLOR



cod. 0053

GIALLO
Yellow
0053



cod. 0120

ARANCIO
Orange
0120

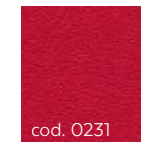

cod. 0231

ROSSO
Red
0231

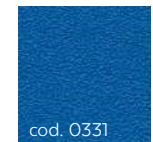

cod. 0331

BLU
Blue
0331

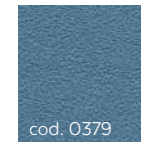

cod. 0379

CELESTE
Light blue
0379



cod. 0426

VERDE ACIDO
Acid green
0426



cod. 0532

AVORIO
Ivory
0532



cod. 0534

NOCCIOLA
Light brown
0534



cod. 0643

GRIGIO PERLA
Light grey
0643



cod. 0651

NERO
Black
0651

Oltre ai 10 colori standard dei tessuti della cartella colori ZEN, è disponibile una gamma estesa di colori con sovrapprezzo del 10% e con un minimo di ordine di 9 pannelli dello stesso tipo. Per il colore bianco il sovrapprezzo è del 20%. Inquadra il QR code per scaricare la cartella colori estesa ZEN. Per maggiori informazioni contattare il customer care a info@steelbox.it. In addition to the 10 standard colors of the ZEN fabric swatch, an extended range of colors is available with a 10% surcharge and a minimum order of 9 panels of the same type. For the color white, there is a 20% surcharge. Scan the QR code to download the extended ZEN color swatch. For more information contact the customer care office export@steelbox.it



Scarica
i colori tessuti.

Download
the fabric colors.

SUPPORTI WALL PER PANNELLO MONOFACCIALE TANGRAM

WALL SUPPORT FOR TANGRAM ONE SIDE PANEL

KITVELCR coppia adesivi con velcro cm Ø8,5
KITVELCR pair of stickers with velcro cm Ø8,5



CEILBO45 per pannelli singoli cm 60/80
CEILBO45 for single panels cm 60/80

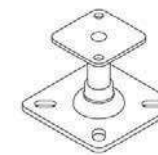

KITVELFE coppia adesivi con velcro e piastrino cm Ø8,5
KITVELFE pair of stickers with velcro and metal plate cm Ø8,5

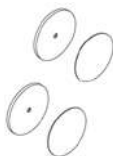

CEILBO90 per pannelli singoli cm 60/80
CEILBO90 for single panels cm 60/80



DESCRIZIONI TECNICHE

TECHNICAL FEATURES

TANGRAM SUPPORTI

I supporti a muro e soffitto sono realizzati con acciaio zincato

Il kitvelfe include un piastrino in metallo di diametro cm 8 di spessore 20/10 è realizzato in lamiera d'acciaio verniciata con polveri epossidiche.

TANGRAM SUPPORTS

Wall and ceiling supports are made galvanized steel

The kitvelfe includes a metal plate with a diameter of 8 cm and a thickness of 20/10, made of steel sheet painted with epoxy powders.

COLORI METALLI

METAL COLOR



cod. 9005

NERO
Black

SOLO PIASTRINO KITVELFE
ONLY THE KITVELFE DISC

ZEN Creo

Il nuovo pannello che soddisfa la voglia di comunicare, personalizzare il proprio ambiente e l'esigenza di ridurre il riverbero acustico. Un pannello fono assorbente sapientemente montato all'interno di una resistente cornice di metallo che può essere appeso al muro come un semplice quadro. Occorre scegliere, ad esempio, un'immagine preferita, il logo aziendale, un prodotto, o altro per personalizzare l'ambiente e renderlo unico.

The new panel that satisfies the desire to communicate, personalize the environment design and the need to reduce acoustic reverb. A sound-absorbing panel expertly mounted inside a resistant metal frame that can be hung on the wall like a simple painting. For example, you need to choose a favorite image, the company logo, a product, or other to customize the environment and make it unique.



Scarica la brochure.
Download the leaflet.



Scarica il technical book.
Download the technical book.











DESCRIZIONI TECNICHE

TECHNICAL FEATURES

Pannello Acustico Zen Creo cm 80x80
Acoustic Panel Zen Creo cm 80x80



Pannello Acustico Zen Creo cm 120x120
Acoustic Panel Zen Creo cm 120x120



ZEN CREO PANEL

Il pannello Zen Creo, è in fibra poliestere riciclata con stampa digitale, con cornice metallica realizzata in acciaio 8/10 tagliata a laser e saldata.

La stampa del pannello ZEN creo è totalmente personalizzabile con qualsiasi immagine a colori. Sarà necessario inviare insieme all'ordine un file PDF/JPG/PNG con una immagine a 300DPI. Assicurarsi di avere tutti i diritti di riproduzione prima di richiedere la stampa, l'azienda declina ogni responsabilità per eventuali copyright.

ZEN CREO PANEL

The Zen Creo panel is in recycled polyester fiber with digital printing, with a metal frame made of 8/10 laser-cut and welded and painted with epoxy powder.

The ZEN CREO panel print is fully customizable with any color image. A PDF/JPG/PNG file with a 300DPI image must be sent along with the order. Make sure you have all reproduction rights before requesting printing, the company declines all responsibility for any copyright.

COLORE METALLO

METAL COLOR

Cornice metallica colore RAL 7016 Antracite
Metal frame color Ral 7016 Anthracite

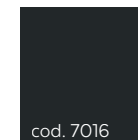

cod. 7016

ANTRACITE
Anthracite
RAL 7016

Zen Go! Bianco, Color & Photo

Zen Go! White, Color & Photo

Il pannello ZEN GO! ha una performance straordinaria ed un rapporto qualità prezzo eccellente, è il prodotto ideale per gli ambienti dove è richiesta la fonoassorbenza con attenzione al valore economico. Disponibile nel suo colore originale, bianco, oppure con tessuto Trevira da uno o entrambi i lati. A richiesta sul pannello può essere riprodotta una immagine a scelta del cliente, per personalizzare l'ambiente ed ottenere benessere acustico e originalità.

The ZEN GO! panel offers extraordinary performance and an excellent value for money ratio, making it the ideal product for environments where sound absorption is required with attention to economic value. It is available in its original color, white, or with Trevira fabric on one or both sides. Upon request, the panel can be customized with an image chosen by the customer, allowing for personalized environments with acoustic well-being and originality.



Scarica la brochure.
Download the leaflet.



Scarica il technical book.
Download the technical book.











ZEN GO! BIANCO

ZEN GO! WHITE

Rotondo
Round

cm Ø 80
cm Ø 60



Esagono
Exagon

cm 60
cm 80



Quadrato
Squared

cm 60x60
cm 80x80
cm 120x120



Rettangolare
Rectangular

cm 120x60











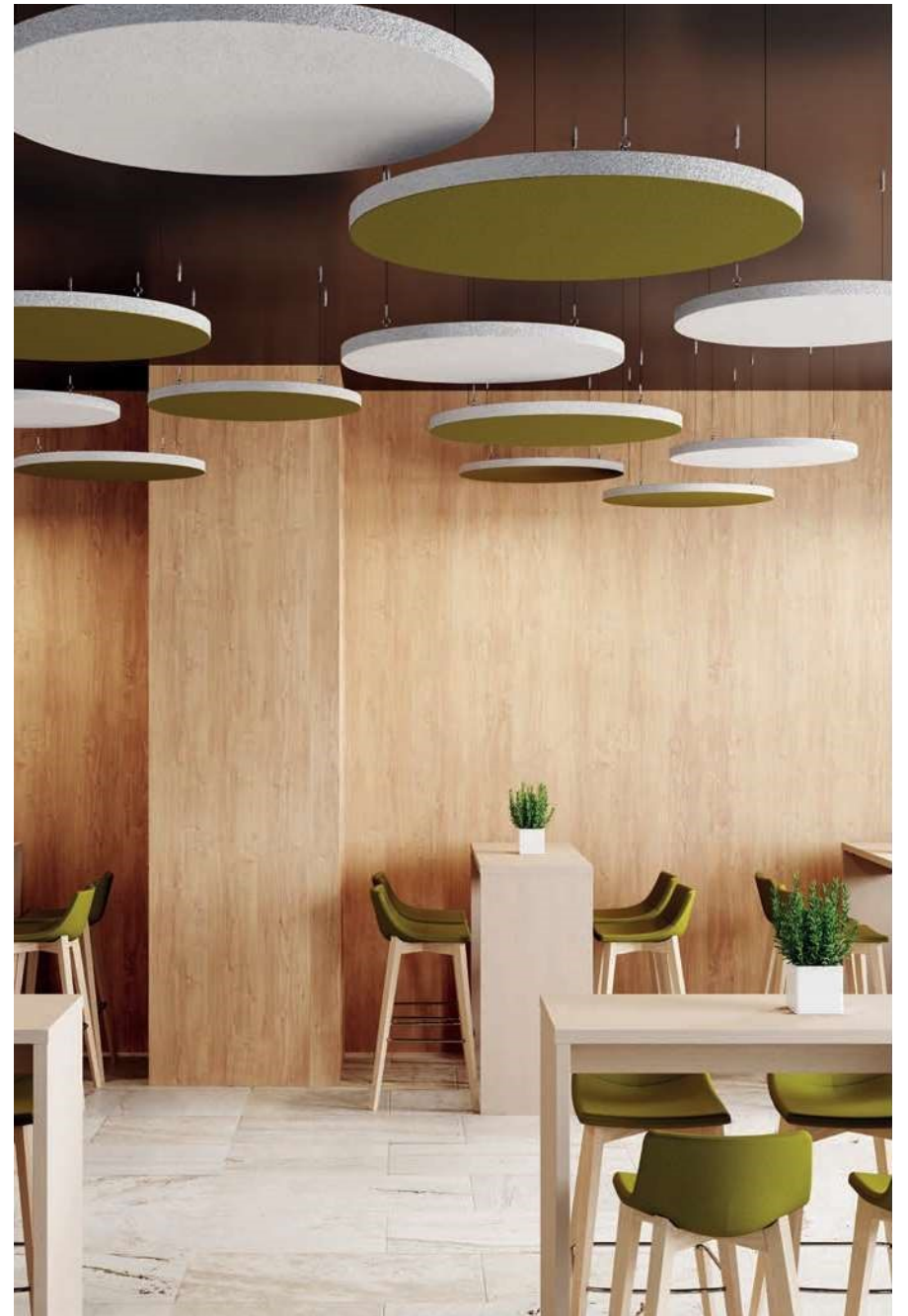





ZEN GO! BIANCO & COLOR 1 LATO BASS TRAP
ZEN GO WHITE & COLOR 1 SIDE BASS TRAP

Nella collezione Zen GO! è disponibile anche un pannello bass trap per aumentare la performance di assorbimento negli angoli delle stanze. Il bass trap è già munito di staffe posteriori per il fissaggio e può essere anche rivestito con tessuto Trevira CS nella parte anteriore.

In the Zen GO! collection, there is also a bass trap panel available to enhance absorption performance in room corners. The bass trap comes with rear brackets for easy mounting and can also be covered with Trevira CS fabric on the front side.



L 60 x P135 x H120 cm
W60 x D135 x H120 cm









ZEN WALL CEILING PANELS





















ZEN GO! COLOR 1 LATO

ZEN GO! COLOR 1 SIDE

Rotondo
Round

cm Ø 80
cm Ø 60



Esagono
Exagon

cm 60
cm 80



Quadrato
Squared

cm 60x60
cm 80x80
cm 120x120



Rettangolare
Rectangular

cm H. 60 x L 120





ZEN GO! COLOR 2 LATI

ZEN GO! COLOR 2 SIDES

Pannello con Stoffa Trevira CS su entrambi i lati
Panel with Trevira CS Fabric on both sides

L'uso del pannello ZEN GO! rivestito da entrambi i lati è consigliato solo per l'uso a Baffle Verticale
The use of the ZEN GO! panel with fabric on both sides is recommended only for vertical baffle use.

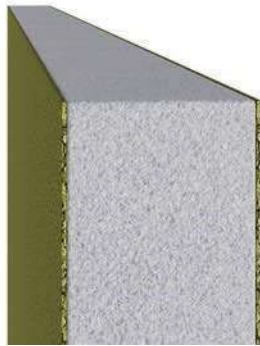



ZEN GO! COLOR 2 LATI

ZEN GO! COLOR 2 SIDES

Fibra pol. sp.40mm tessuto 2 lati
Pet fiber sp.40mm fabric 2 sides

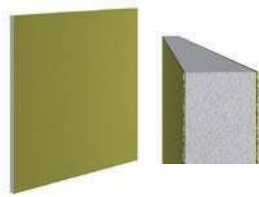

Fibra pol. esagonale sp.40mm tessuto 2 lati
Pet fiber exagonal sp.40mm fabric 2 sides

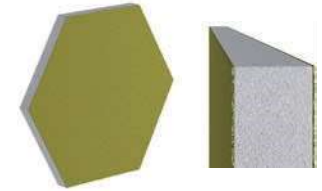

Fibra pol. 60x120 sp.40mm tessuto 2 lati
Pet fiber 60x120 sp.40mm fabric 2 sides

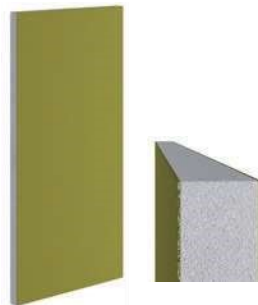

Fibra pol. tondo sp.40mm tessuto 2 lati
Pet fiber round sp.40mm fabric 2 sides

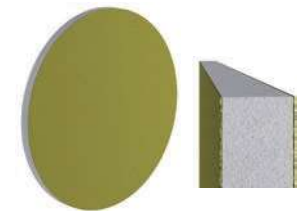



















ZEN GO! PHOTO

ZEN GO! PHOTO

La stampa del pannello ZEN GO! PHOTO è totalmente personalizzabile con qualsiasi immagine a colori. Sarà necessario inviare insieme all'ordine un file PDF/JPG/PNG con una immagine a 300DPI. Assicurarsi di avere tutti i diritti di riproduzione prima di richiedere la stampa, l'azienda declina ogni responsabilità per eventuali copyright.

Pannello per l'abbattimento del riverbero acustico totalmente ecologico, ottenuto dal riciclo post consumo di bottiglie di plastica (PET) e 100% riciclabile

The ZEN GO! PHOTO panel print is fully customizable with any color image. A PDF/JPG/PNG file with a 300DPI image must be sent along with the order. Make sure you have all reproduction rights before requesting printing, the company declines all responsibility for any copyright.

Ecological acoustic panel to reduce reverberation, obtained from recycled of plastic bottles (PET) and 100% recyclable

Suggerimenti: I pannelli in fibra possono essere applicati alla parete con collanti (esempio Silicene).

Remarks: Pet fiber panels can be wall mounted with adhesives (e.g. Silicene)

Rotondo
Round

cm Ø 80
cm Ø 60



Esagono
Exagon

cm 60
cm 80



Quadrato
Squared

cm 60x60
cm 80x80
cm 120x120



Rettangolare
Rectangular

cm 120x60





ZEN GO! CANDY

ZEN GO! CANDY

Pannello Zen GO! Candy 17 pannelli di divisi da dischi di metallo di spessore 0.8 decimi.
Completo di Kit di montaggio ceiling.

The Candy panel consists of 17 fiber panels divided by metal disks of 0.8 millimeters thickness.
It comes complete with a ceiling mounting kit.



cm Ø19 x H77



Zen Go! per la scuola

Zen Go! for schools





Zen Go! per ristoranti e mense

Zen Go! for restaurants and canteens









Zen Go! per uffici, spazi pubblici e privati

Zen Go! for office, public and private spaces

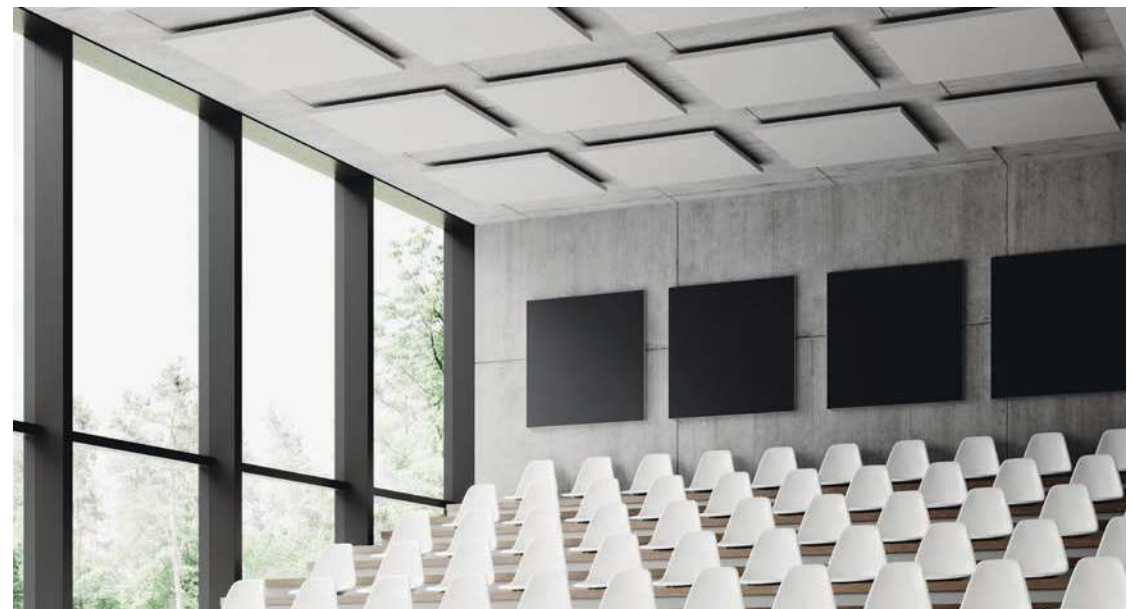







ZEN GO! WHITE - ZEN GO! COLOR- ZEN GO! PHOTO

ZEN GO! WHITE - ZEN GO! COLOR

Single panel ZEN GO! White

H 60 x L/W 60 cm
 H 60 x L/W 120 cm
 H 80 x L/W 80 cm
 H 120 x L/W 120 cm

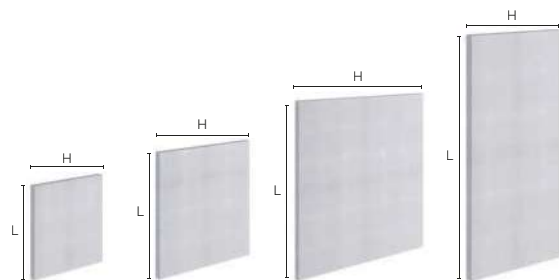

Pannello ZEN GO! Candy
 ZEN GO! panel Candy

Ø 19 cm



ZEN GO! Color
 1 lato - entrambi i lati
 1 side - both sides

H 60 x L/W 60 cm
 H 60 x L/W 120 cm
 H 80 x L/W 80 cm
 H 120 x L/W 120 cm

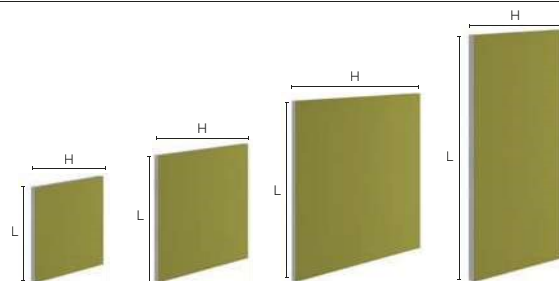

Pannello ZEN GO! Bass trap
 L60 x P135 x H120 cm
 ZEN GO! Panel bass trap
 W60 x D135 x H120

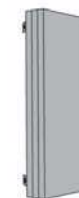

Round panel

Ø60 cm
 Ø80 cm



ZEN GO! Photo
 L60 x P135 x H120 cm

H 120 x L/W 120 cm
 H 80 x L/W 80 cm
 H 60 x L/W 120 cm

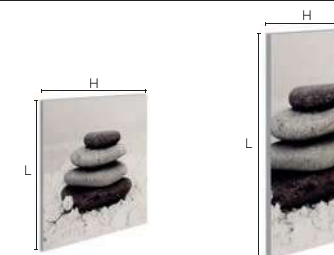

Exagonal panel

R60 cm
 R60 cm

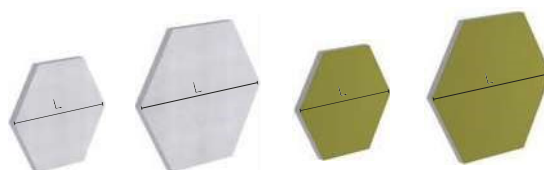

ZEN GO! Photo

H 80 x L/W 80 cm
 Ø 80 cm



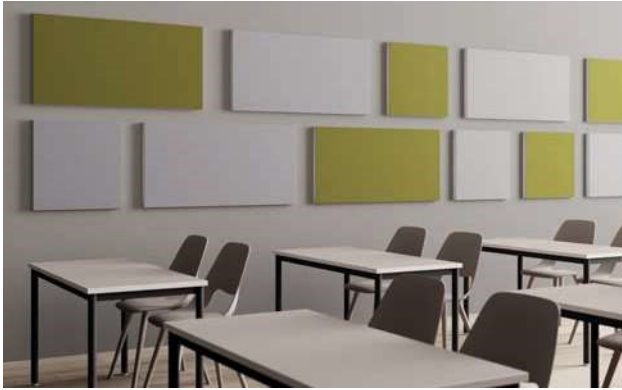

DESCRIZIONI TECNICHE

TECHNICAL FEATURES

PANNELLI DELLA SERIE ZEN GO! BIANCHI

Pannello per l'abbattimento del riverbero acustico totalmente ecologico, ottenuto dal riciclo post consumo di bottiglie di plastica (PET) e 100% riciclabile.

- Spessore 45mm e densità 50Kg/m³
- Risponde ai Criteri Ambientali Minimi (CAM).
- Non contiene sostanze pericolose ai sensi del D.M. 16/02/93
- Prodotti adatti al contatto con adulti e bambini ai sensi dello Standard
- 100 OEKO-TEX.
- Resistente agli agenti chimici (acidi, sali, idrocarburi), ai funghi, ai batteri ed ai microrganismi; immarcescibile. Non perde peso e non rilascia fibre durante il trasporto e l'installazione. Non esistono precauzioni di maneggio ed immagazzinaggio, né si conoscono effetti dannosi per la salute.

Rapporto di reazione al fuoco
Classe di reazione al fuoco Classe 1 UNI 9174.

Pannello Zen GO! Candy: 17 dischi in fibra bianca sp45mm, divisi da lamiera 0.8 decimi tagliati a laser e verniciati con polveri epossidiche, compreso di kit con cavo di fissaggio a soffitto incluso.

CARATTERISTICHE DI RESISTENZA AL FUOCO DEL TESSUTO "TREVIRA CS"

Italia - Classe 1 / Germania - B1 DIN 4102 / Francia - M1 / Austria - B1 OENORM B3825 - Q1 OENORM 3800 Part. 1 - BS 5852 Crib 5 using a CM Foam 35 kg/cu.m - EN 1021 Part.1-2 using a CM Foam 35 kg/cu.m - USA Calif. Bull. 117 June 2013 - EN 13501 - 1,1,2 : B-s1, d0 - EN 13773 Burning Behaviour: class 1 - EN ISO 6940/6941 / Svizzera - Fire Protection Classification: 5.3

ZEN GO! WHITE PANELS

Panel for acoustic reverberation reduction, completely ecological, obtained from post-consumer recycling of plastic bottles (PET) and 100% recyclable.

- Panel thickness 45mm, density 50Kg/m³
- Complies with Minimum Environmental Criteria (CAM).
- Does not contain hazardous substances according to D.M. 16/02/93
- Products suitable for contact with adults and children according to the Standard 100 OEKO-TEX.
- Resistant to chemical agents (acids, salts, hydrocarbons), fungi, bacteria, and microorganisms; everlasting. It does not lose weight and does not release fibers during transport and installation. There are no handling and storage precautions, nor are there known harmful effects on health.

Fire reaction rating
Fire reaction class Class 1 UNI 9174.

Zen GO! Candy panel: 17 white fiber disks with a thickness of 45mm, separated by laser-cut 0.8 millimeter steel plates painted with epoxy resin powder, and including a kit with ceiling mounting cable.

FIRE RETARDANT FABRIC FEATURES "TREVIRA CS"

Italy- Classe 1 / Germany- B1 DIN 4102 / France - M1 / Austria - B1 OENORM B3825 - Q1 OENORM 3800 Part. 1 - BS 5852 Crib 5 using a CM Foam 35 kg/cu.m - EN 1021 Part.1-2 using a CM Foam 35 kg/cu.m
- USA Calif. Bull. 117 June 2013 - EN 13501 - 1,1,2 : B-s1 , d0
- EN 13773 Burning Behaviour: class 1 - EN ISO 6940/6941 / Switzerland - Fire Protection Classification: 5.3



COLORI TESSUTO TREVIRA CS

FABRIC TREVIRA CS COLOR



cod. 0053
GIALLO
Yellow
0053



cod. 0120
ARANCIO
Orange
0120

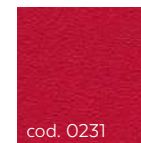

cod. 0231
ROSSO
Red
0231

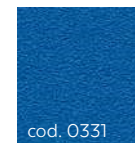

cod. 0331
BLU
Blue
0331



cod. 0379
CELESTE
Light blue
0379



cod. 0426
VERDE ACIDO
Acid green
0426



cod. 0532
AVORIO
Ivory
0532



cod. 0534
NOCCIOLA
Light brown
0534



cod. 0643
GRIGIO PERLA
Light grey
0643



cod. 0651
NERO
Black
0651

COLORI METALLI

METAL COLORS

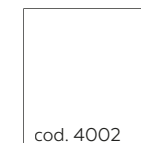

cod. 4002
BIANCO
White
RAL 9003

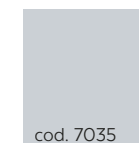

cod. 7035
GRIGIO CHIARO
Light grey
RAL 7035

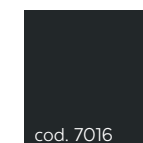

cod. 7016
ANTRACITE
Anthracite
RAL 7016

Altri colori RAL sono disponibili su richiesta con un sovrapprezzo del 10%

Other RAL colors are available on demand with 10% overprice

I codici colori dei metalli corrispondono alle codifiche RAL standard internazionali

The color codes of our metal match with International Standard RAL

Oltre ai 10 colori standard dei tessuti della cartella colori ZEN, è disponibile una gamma estesa di colori con sovrapprezzo del 10% e con un minimo di ordine di 9 pannelli dello stesso tipo. Per il colore bianco il sovrapprezzo è del 20%. Inquadra il QR code per scaricare la cartella colori estesa ZEN. Per maggiori informazioni contattare il customer care a info@steelbox.it. In addition to the 10 standard colors of the ZEN fabric swatch, an extended range of colors is available with a 10% surcharge and a minimum order of 9 panels of the same type. For the color white, there is a 20% surcharge. Scan the QR code to download the extended ZEN color swatch. For more information contact the customer care office export@steelbox.it



Scarica
i colori tessuti.

Download
the fabric colors.

Zen Go! Supporti per soffitto

Zen Go! Supports for ceiling

I pannelli hanno un supporto in plastica pre montato per facilitare il montaggio a baffle orizzontale e a parete.

The panels come with a pre-fitted plastic backing for easy horizontal baffle and wall mounting.

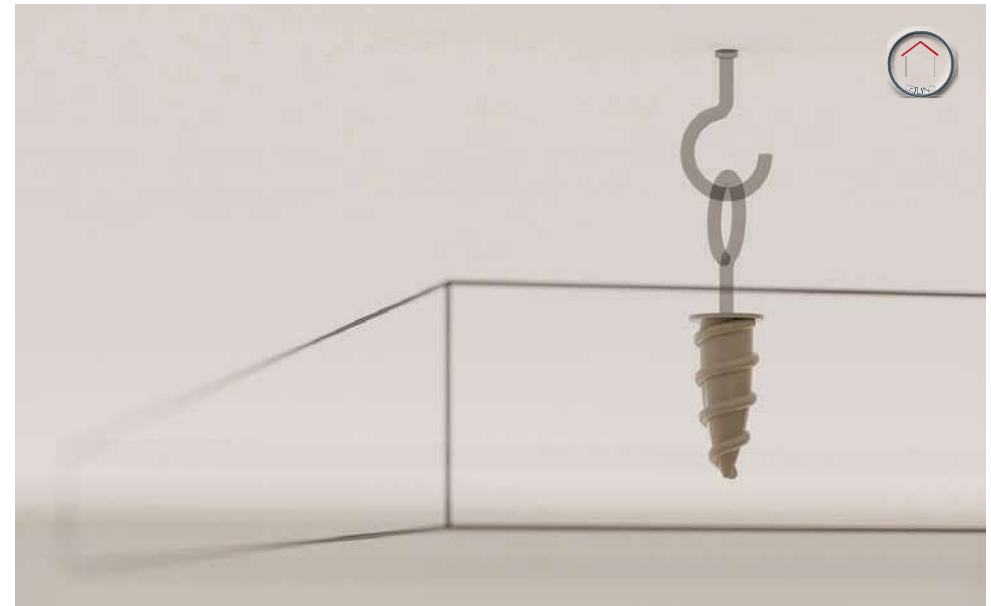
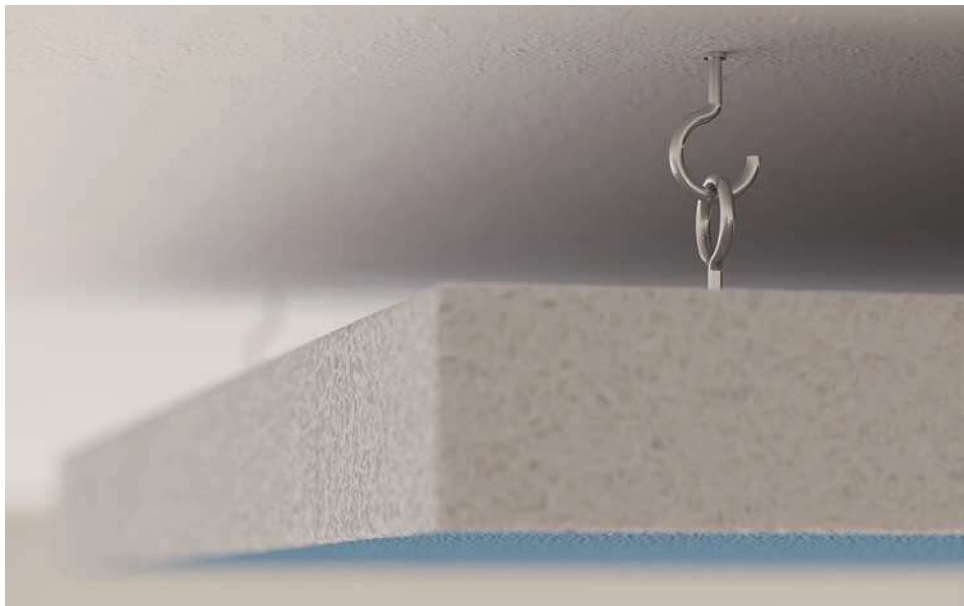



SUPPORTI SOFFITO E MURO
WALL & CEILING SUPPORTS



Staffa Ceiling per pannelli montati a baffle
Ceiling support for baffle panels

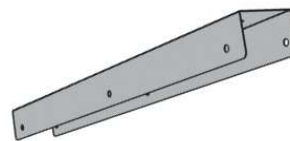

Cavetti a sospensione orizzontale
Cables for horizontal suspension

I morsetti per l'installazione sospesa sono realizzati in acciaio cromato di prima qualità mentre i cavi di sostegno anch'essi in acciaio hanno un diametro di 1 mm. I sistemi di installazione sospesa Zen sono certificati dall'Istituto Giordano a norma CE
The clamps for suspended installation are made of high-quality chrome-plated steel, while the supporting cables, also made of steel, have a diameter of 1mm.
The Zen suspended installation systems are CE-certified by the Giordano Institute.



Cavetti a sospensione verticale
Cables for vertical suspension

Per il fissaggio a baffle verticale il pannello è predisposto con 2 fori per essere fissato con i cavetti in acciaio disponibili a listino.
For vertical baffle mounting, the panel is set up with 2 holes to be fixed with the steel cables available in the price list.



Zen Go! Supporti per parete

Zen Go! Supports for walls



Gancio di fissaggio parete
Wall fixing hook





In alternativa si può utilizzare il silicone oppure le viti (non forniti)

Alternatively it's possible to use silicon or screws (not supplied)



Zen Soundshaper® Desking ed accessori

Zen Soundshaper® Desking and accessories

Aggiungi privacy e prestazioni acustiche alla scrivania con Zen Soundshaper® Desking. Fissato di fronte e/o ai lati di qualsiasi scrivania, con morsetti o semplici staffe metalliche, è possibile accessorizzare il piano con elementi portaoggetti per tutti i dispositivi tecnologici, come tablets e smartphones o una bottiglia d'acqua o semplicemente un grazioso porta fiore. Esplora l'intera gamma di Zen Desking per scoprire una grande varietà di soluzioni.

Add privacy and acoustic performance to the desk with Zen Soundshaper® Desking. Attached to the front and sides of any desk with clamps or simple metal brackets it's possible to accessorize the top with storage elements for all the technological devices, like tablets and mobile phones or water bottles or just a gracious flower pot. Explore the entire range of Zen desking to discover a great capacity of solutions.



Scarica la brochure.
Download the leaflet.



Scarica il technical book.
Download the technical book.











Morsetto per front panel da postazione singola.
Front panel clamp for single desk



Morsetto per bench lineare.
Front panel clamp for linear bench.



Coppia supporti frontal panel da appoggio
Set of 2 supports for self standing front panel



Morsetto per lato esterno sopra gamba per piani da mm 18-30
Front panel clamp for side use for tops of mm 18-30



I differenti supporti per il pannello frontale per scrivanie offrono vantaggi di configurazioni sia per postazioni singole che per bench desking. Il morsetto è la soluzione ideale per l'utente che non vuole forare il piano di lavoro

The multiple choice for the front panel support allows the possibility of many configurations either for single workstation or bench desking. The clamp is a good solution to avoid drilling the worktop.

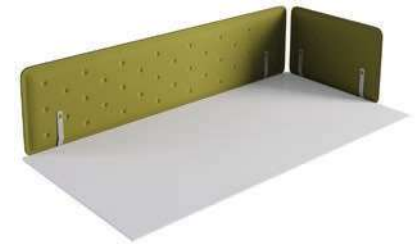
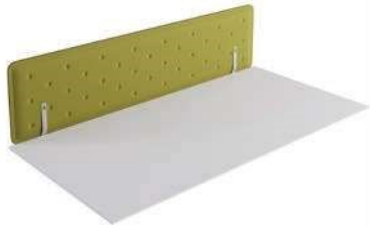

Supporto per front panel postazione singola.
Front panel support for single workstation

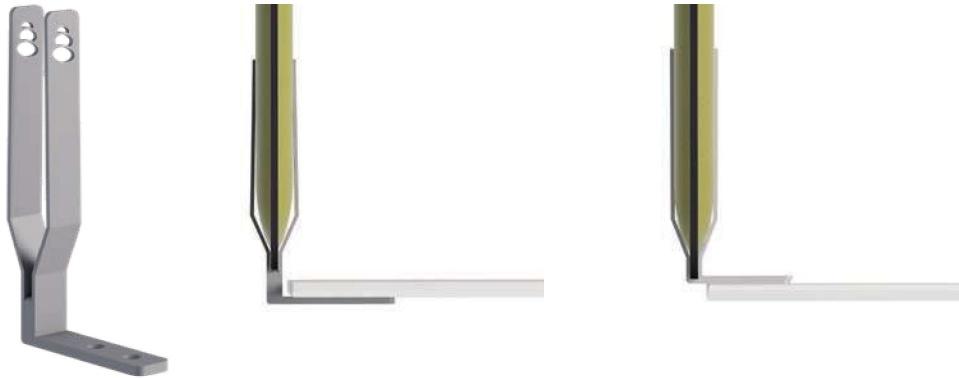

Supporto per front panel da bench desking.
Front panel support for bench desking

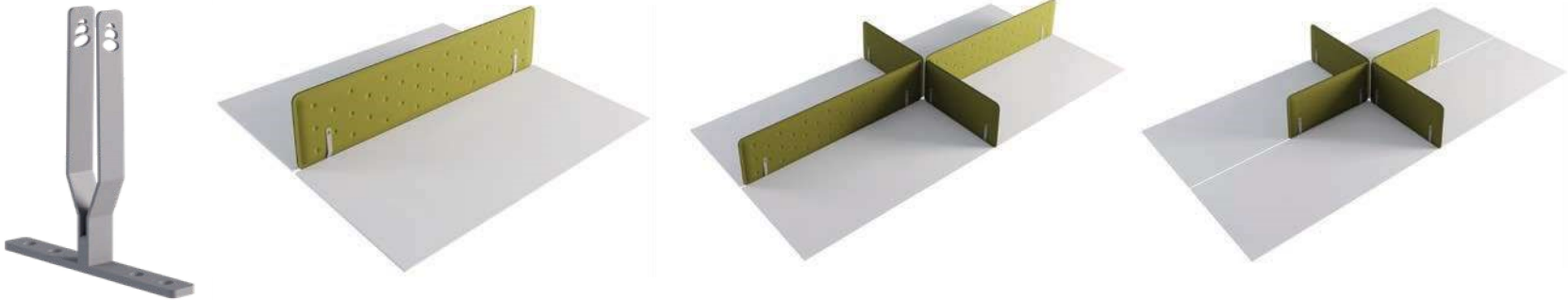

Supporto per front panel da appoggio su piano
Free standing front panel support



Coppia supporti front panel per 2 pannelli separati.
Utilizzare solo pannelli cm H. 40.
Set of 2 brackets for double for 2 separate panels
Use only cm H. 40 panels.



Staffe per aggancio modesty panel.
Brackets for modesty panel.



Sul bordo del pannello frontale da scrivania è possibile agganciare accessori strategici accessori per migliorare l'efficienza del piano di lavoro o semplicemente decorare la scrivania.
On the edge of the workstation front panel it's possible to hook strategical accessories to improve the efficiency of the worktop or simply decorate the desk.

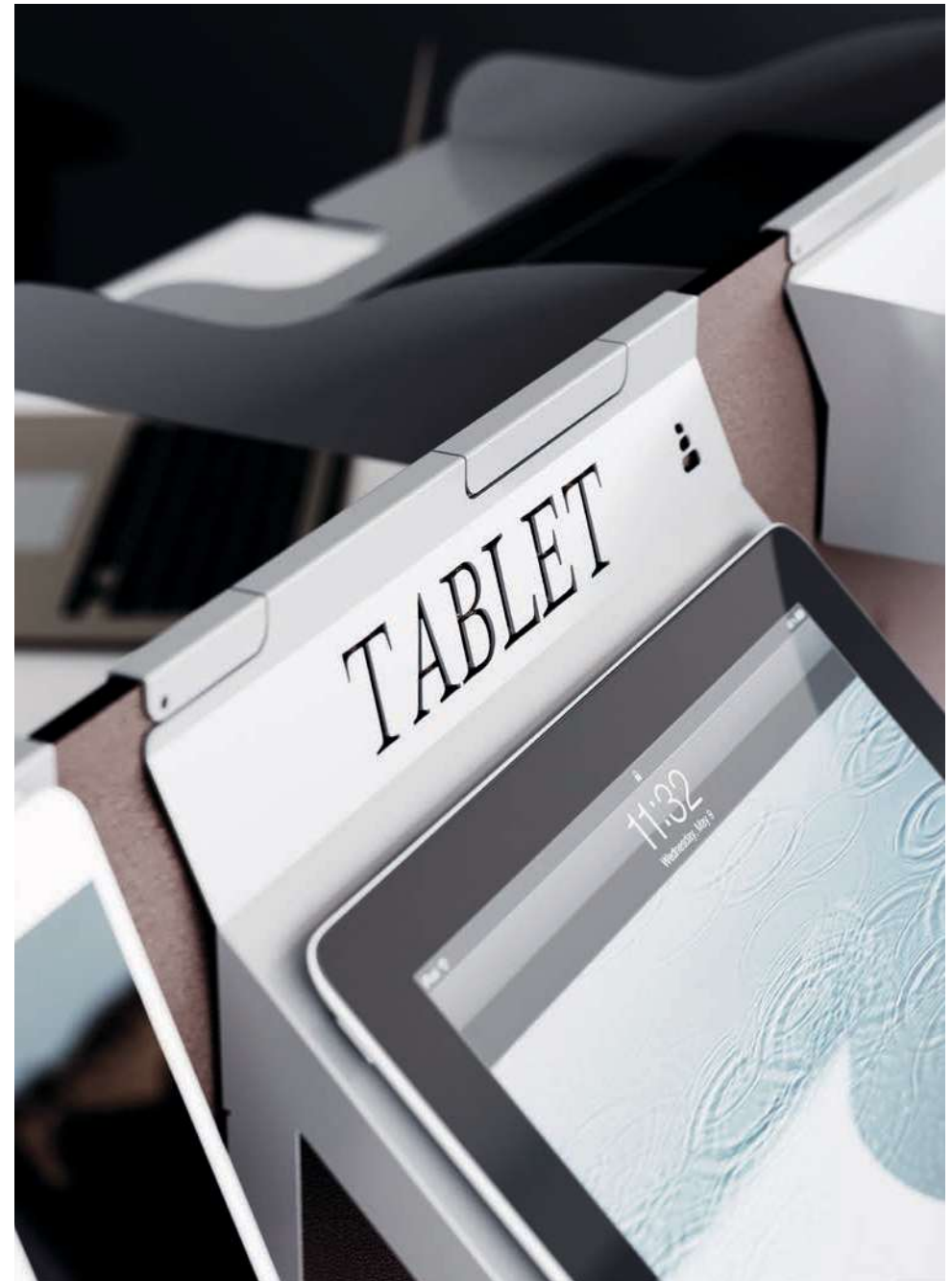

Il profilo di aggancio accessori - brevetto Metalway - offre la possibilità di alloggiare accessori complanari ai due lati del pannello permettendo ad entrambi gli operatori di usufruire di tutto lo spazio disponibile senza interruzioni.
The edge to hook the accessories - patented Metalway - offers the possibility to have two accessories at time for both operators to take advantage of all available space without interruptions.



Gancio portaborse
Bag hook



Porta monitor
Monitor stand



Kit 2 ganci appendiabiti
Set of 2 cloth hangers





Fioriera per pannelli
Planter for panels

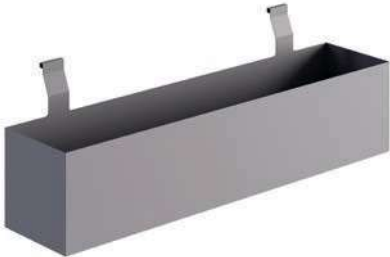

PANNELLI ACUSTICI BIFACCIALI ZEN SOUNDSHAPER®

DOUBLE SIDE ACOUSTIC PANELS ZEN SOUNDSHAPER®

Pannello Acustico Zen Soundshaper®
Acoustic Panel Zen Soundshaper®

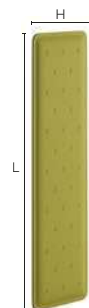

Larghezze disponibili
Available widths
L/W 60 / 80 / 100 / 120 / 140 / 160 / 180 Cm

Altezze disponibili
Available heights
H 40 Cm

Pannello Acustico Zen Soundshaper®
Acoustic Panel Zen Soundshaper®



Larghezze disponibili
Available widths
L/W 60 / 80 / 100 / 120 / 140 / 160 / 180 Cm

Altezze disponibili
Available heights
H 60 Cm



DESCRIZIONI TECNICHE

TECHNICAL FEATURES

ZEN DESKING

I pannelli bifacciali sono realizzati in fibra di poliestere riciclata termoformata con un inserto ignifugo honeycomb. Tecnologia brevettata Soundshaper®. I bordi sono tagliati a laser. I pannelli sono rivestiti con tessuto bi-elastico stretch “TREVIRA CS”.

CARATTERISTICHE DI RESISTENZA AL FUOCO DEL TESSUTO “TREVIRA CS”

Italia - Classe 1 / Germania - B1 DIN 4102 / Francia - M1 / Austria - B1 OENORM B3825 - Q1 OENORM 3800 Part. 1 - BS 5852 Crib 5 using a CM Foam 35 kg/cu.m - EN 1021 Part.1-2 using a CM Foam 35 kg/cu.m - USA Calif. Bull. 117 June 2013 - EN 13501 - 1,1,2 : B-s1, d0 - EN 13773 Burning Behaviour: class 1 - EN ISO 6940/6941 / Svizzera - Fire Protection Classification: 5.3

ZEN DESKING

The double side panels are made with recycled polyester fiber, thermoformed, with internal fireproof honeycomb structure. Soundshaper® technology is patented. The edges of the panels are laser cut. Panels are upholstered with double stretch fabric “TREVIRA CS”.

FIRE RETARDANT FABRIC FEATURES “TREVIRA CS”

Italy- Classe 1 / Germany- B1 DIN 4102 / France - M1 / Austria - B1 OENORM B3825 - Q1 OENORM 3800 Part. 1 - BS 5852 Crib 5 using a CM Foam 35 kg/cu.m - EN 1021 Part.1-2 using a CM Foam 35 kg/cu.m - USA Calif. Bull. 117 June 2013 - EN 13501 - 1,1,2 : B-s1, d0 - EN 13773 Burning Behaviour: class 1 - EN ISO 6940/6941 / Switzerland - Fire Protection Classification: 5.3

TESSUTO

FABRIC TREVIRA CS



cod. 0053

GIALLO
Yellow
0053



cod. 0120

ARANCIO
Orange
0120

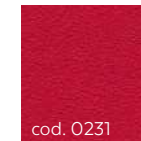

cod. 0231

ROSSO
Red
0231



BLU
Blue
0331

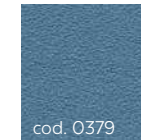

cod. 0379

CELESTE
Light blue
0379



cod. 0426

VERDE ACIDO
Acid green
0426

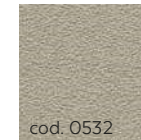

cod. 0532

AVORIO
Ivory
0532

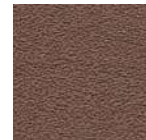

NOCCIOLA
Light brown
0534



cod. 0643

GRIGIO PERLA
Light grey
0643



cod. 0651

NERO
Black
0651

Oltre ai 10 colori standard dei tessuti della cartella colori ZEN, è disponibile una gamma estesa di colori con sovrapprezzo del 10% e con un minimo di ordine di 9 pannelli dello stesso tipo. Per il colore bianco il sovrapprezzo è del 20%. Inquadra il QR code per scaricare la cartella colori estesa ZEN. Per maggiori informazioni contattare il customer care a info@steelbox.it. In addition to the 10 standard colors of the ZEN fabric swatch, an extended range of colors is available with a 10% surcharge and a minimum order of 9 panels of the same type. For the color white, there is a 20% surcharge. Scan the QR code to download the extended ZEN color swatch. For more information contact the customer care office export@steelbox.it.



Scarica
i colori tessuti.

Download
the fabric colors.

DESKING E ACCESSORI

DESKING AND ACCESSORIES

Coppia morsetti Front panel
Set of 2 front panel clamps

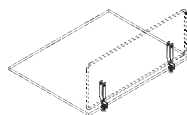

Coppia morsetti per bench lineare
Set of 2 front panel clamps for linear bench

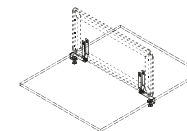

Coppia morsetti per lato esterno sopra gamba per piani mm 18
Set of 2 front panel clamps for mm 18 tops to use on the side

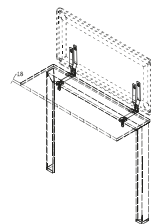

Coppia supporto front panel
Set of 2 brackets for front panel

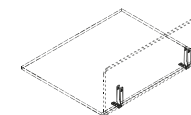

Coppia morsetti per lato esterno sopra gamba per piani mm 25-30
Set of 2 front panel clamps for mm 25-30 tops to use on the side

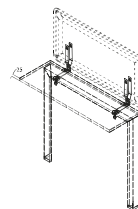

Coppia supporti Front panel per scrivanie Bench
Set of 2 brackets for benching desks front panels

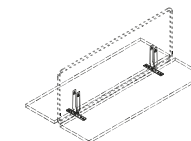

DESKING E ACCESSORI

DESKING AND ACCESSORIES

Coppia supporti per front panel da appoggio
set of 2 supports for self standing front panel

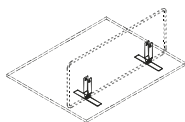

Coppia supporti Front panel 2 pannelli
Set of 2 brackets for 2 panels

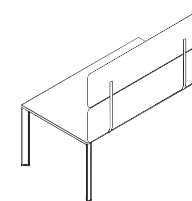

Coppia supporti Front panel 2 pannelli per Bench
Set of 2 brackets for 2 panels for Bench

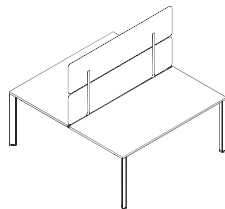

Staffe per aggancio modesty panel
Brackets for modesty panel

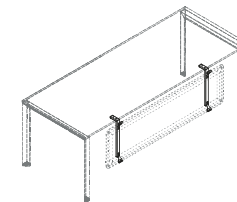

DESKING E ACCESSORI

DESKING AND ACCESSORIES

Vaschetta A4
A4 paper tray

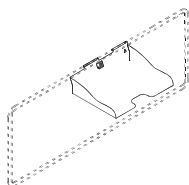

Porta penne
Pen holder

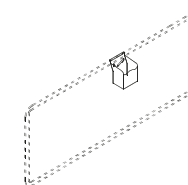

Supporto tablet
Tablet stand

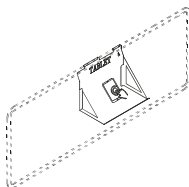

Porta bottiglie
Bottle holder

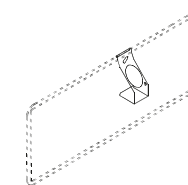

Lavagna metallica
Metallic board

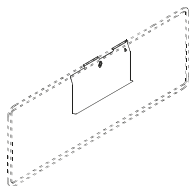

Porta fiori
Flower stand

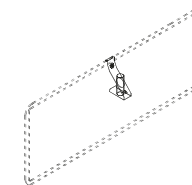

Supporto cellulare
Smartphone stand

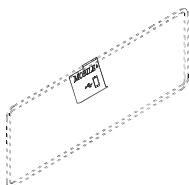

DESCRIZIONI TECNICHE

TECHNICAL FEATURES

SUPPORTI DESKING

I supporti desking sono realizzati in lamiera d'acciaio saldata e presso-piegata, verniciata con polveri epossidiche con incisioni e tagli al laser.

Gli accessori desking sono realizzati in lamiera d'acciaio 10/10 presso-piegata con tagli ed incisioni al laser e verniciate con polveri epossidiche.

DESKING SUPPORTS

Desking supports are made by steel foil welded and press formed, painted with epoxy resin powder with laser cut and engravings.

Desking accessories are made by 10/10 press formed steel foil, painted with epoxy resin powder with laser cut and engravings

COLORI METALLI

METAL COLORS

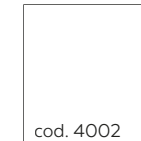

cod. 4002

BIANCO
White
RAL 9003



cod. 7035

GRIGIO CHIARO
Light grey
RAL 7035

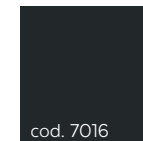

cod. 7016

ANTRACITE
Anthracite
RAL 7016

Altri colori RAL sono disponibili su richiesta con un sovrapprezzo del 10%

Other RAL colors are available on demand with 10% overprice

I codici colori dei metalli corrispondono alle codifiche RAL standard internazionali

The color codes of our metal match with International Standard RAL

ZEN Lighting

Il pannello Zen coniugato con la nuova tecnologia Led di illuminazione è la soluzione integrata perfetta che combina benessere acustico e necessità di illuminazione della postazione. In tre supporti differenti, pannello rettangolare, pannello quadrato, e pannello sferico, le lampade offrono sia luce naturale Led 5050 a 4000k certificata con diverse capacità di watts per il pannello Zen soundshaper® e per Zen Sphere è possibile ottenere una gradazione di luce a 3000k, 4000k, 6000k, con lampada Ø 290, certificata CE con driver a tensione costante.

Zen panel combined with the new LED lighting technology is the perfect integrated solution that mixes acoustic well-being and the need for illuminating the workstation. In three different supports, rectangular panel, square panel, and spherical panel, the lamps offer natural light Led 5050, 4000k certified with different watts capacities for the zen soundshaper® panel, while for Zen Sphere it is possible to obtain a gradation of light at 3000k, 4000k, 6000k, with lamp Ø 290, CE certified with constant voltage driver.



Scarica la brochure.
Download the leaflet.



Scarica il technical book.
Download the technical book.







ZEN WALL CEILING PANELS

Pannello acustico Zen Soundshaper® con lampada led luce colore 3000k cm L140 compreso di kit di sospensione per soffitto. Consumo nominale 28W.

Acoustic Panel Zen Soundshaper® with led lamp light color 3000K cm 140 with suspending kit included. Nominal consumption 28w.



Pannello acustico Zen Soundshaper® con 2 faretto led luce colore 3000k cm 140 compreso di kit di sospensione per soffitto. Consumo nominale 12W.

Acoustic Panel Zen Soundshaper® with 2 led spots light color 3000K cm 140 with suspending kit included. Nominal consumption 12w

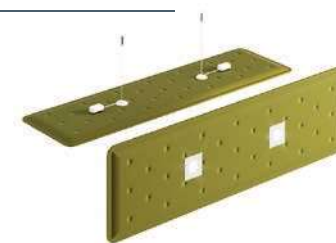

ZEN WALL CEILING PANELS

ZEN SPHERE PANEL WHIT LED LAMP

Ø90
Ø120

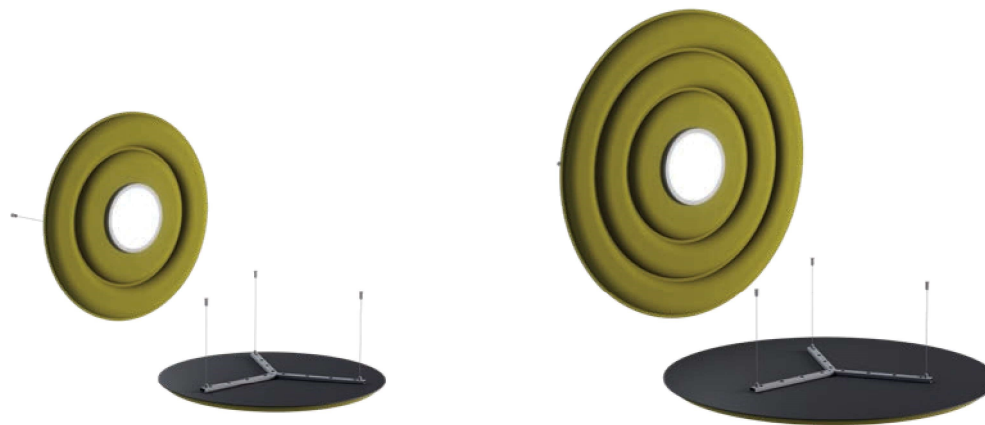

ZEN SQUARE FLAT WITH 1 LED LAMP

118 x 118 cm

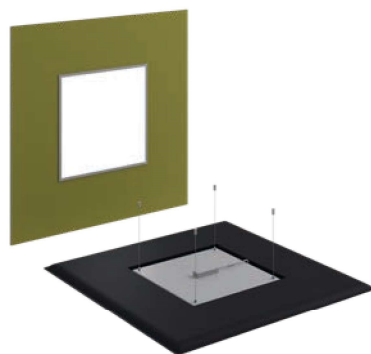

ZEN SOUNDSHAPER® WHIT LED LAMP

L 140 x H 40 cm
L 180 x H 40 cm



DESCRIZIONI TECNICHE

TECHNICAL FEATURES

PANNELLO ZEN LAMPADA

LAMPLLUN: Pannello da cm. 140 con lampada led compreso kit di sospensione a soffitto: Lampada da incasso per illuminazione diretta composta da profilato estruso in alluminio, cover in policarbonato opaco, strip LED 5050 luce naturale 4000° K certificata CE e RoHs, driver a tensione costante certificato CE, SELV (Safety Extra Low Voltage), classe di isolamento II. Consumo nominale 28W e 459lm.

LAMPLFAR: Pannello da cm. 140 con 2 mini led spots, CE and RoHs certifications, 2 CE certified electronic drivers, Class II insulation. Nominal power 12W.

LAMPD090/120: Pannello zen sphere diametro cm 90/120 con lampada Led integrata, compresa di kit sospensione per soffitto con driver integrato per luce colore 3000° K , 4000° K, 6000° K , Ø 290mm, certificata CE e RoHs, driver a tensione costante certificato CE, SELV (Safety Extra Low Voltage), classe di isolamento II. Consumo nominale 24W e 2160lm.

LAMP59X4: Pannello acustico Zen Square liscio cm L 118x118 con lampada Led integrata, compreso di kit di sospensione per soffitto 3600lm, a 4000° K, potenza 36W, 220-240V e classe energetica E.

Altre tipologie di gradazioni Kelvin disponibili su richiesta

Accessori per l'installazione sospesa:

I telai per l'installazione sospesa dei pannelli mono facciali sono realizzati in tubolare di acciaio cm 3x1,5 di spessore 15/10 integrati con cavetti d'acciaio di 1mm di diametro con cavetti di acciaio cromato di prima qualità.

I morsetti per l'installazione sospesa senza telaio sono realizzati in acciaio cromato di prima qualità mentre i cavi di sostegno anch'essi in acciaio hanno un diametro di 1 mm.

I sistemi di installazione sospesa Zen sono certificati dall'Istituto Giordano a norma CE

CARATTERISTICHE DI RESISTENZA AL FUOCO DEL TESSUTO "TREVIRA CS"

Italia - Classe 1 / Germania - B1 DIN 4102 / Francia - M1 / Austria - B1 OENORM B3825 - Q1 OENORM 3800 Part. 1 - BS 5852 Crib 5 using a CM Foam 35 kg/cu.m - EN 1021 Part.1-2 using a CM Foam 35 kg/cu.m - USA Calif. Bull. 117 June 2013 - EN 13501 - 1,1,2 : B-s1, d0 - EN 13773 Burning Behaviour: class 1 - EN ISO 6940/6941 / Svizzera - Fire Protection Classification: 5.3

PANEL ZEN LAMPS

LAMPLLUN: 140 cm Panel with Led light and ceiling suspension kit: Direct illumination recessed lamp made of extruded aluminum body with matt polycarbonate cover, strip LED 5050, 4000° K natural light, CE and RoHs certifications, CE certified constant voltage electronic driver, Class II insulation. Nominal power 28W e 459lm.

LAMPLFAR: 140 cm Panel with 2 mini Led light spots and ceiling suspension kit. CE and RoHs certifications, 2 CE certified electronic drivers, Class II insulation. Nominal power 12W.

LAMPD090/120: Zen sphere panel diameter 90/120 cm with integrated Led lamp, including ceiling suspension kit with integrated driver for 3000° K , 4000° K, 6000° K , Ø 290mm, CE and RoHs certified light color, CE and RoHs certified constant voltage driver, SELV (Safety Extra Low Voltage), insulation class II. Nominal consumption 24W and 2160lm.

LAMP59X4: Zen Square smooth acoustic panel measuring 118x118 cm with integrated LED lamp, including a suspension kit for ceilings. The LED lamp has a brightness of 3600 lumens, a color temperature of 4000K, power consumption of 36W, operates at 220-240V, and has an energy efficiency class of E.

Other Kelvin gradations available upon request

Accessories for suspended installation:

The frames for suspending single-sided panels are constructed from 3x1.5 cm steel tubular with a thickness of 15/10, integrated with 1mm diameter steel cables coated with high-quality chrome-plated steel cables.

The clamps for frameless suspended installation are made of high-quality chrome-plated steel, while the supporting cables, also made of steel, have a diameter of 1mm.

The Zen suspended installation systems are CE-certified by the Giordano Institute.

FIRE RETARDANT FABRIC FEATURES "TREVIRA CS"

Italy- Classe 1 / Germany- B1 DIN 4102 / France - M1 / Austria - B1 OENORM B3825 - Q1 OENORM 3800 Part. 1 - BS 5852 Crib 5 using a CM Foam 35 kg/cu.m - EN 1021 Part.1-2 using a CM Foam 35 kg/cu.m - USA Calif. Bull. 117 June 2013 - EN 13501 - 1,1,2 : B-s1 , d0 - EN 13773 Burning Behaviour: class 1 - EN ISO 6940/6941 / Switzerland - Fire Protection Classification: 5.3

COLORI TESSUTO TREVIRA CS

FABRIC TREVIRA CS COLOR



cod. 0053

GIALLO
Yellow
0053



cod. 0120

ARANCIO
Orange
0120

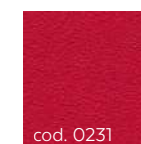

cod. 0231

ROSSO
Red
0231

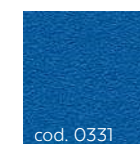

cod. 0331

BLU
Blue
0331

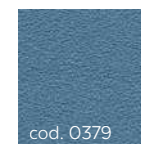

cod. 0379

CELESTE
Light blue
0379



cod. 0426

VERDE ACIDO
Acid green
0426



cod. 0532

AVORIO
Ivory
0532



cod. 0534

NOCCIOLA
Light brown
0534



cod. 0643

GRIGIO PERLA
Light grey
0643



cod. 0651

NERO
Black
0651

Oltre ai 10 colori standard dei tessuti della cartella colori ZEN, è disponibile una gamma estesa di colori con sovrapprezzo del 10% e con un minimo di ordine di 9 pannelli dello stesso tipo. Per il colore bianco il sovrapprezzo è del 20%. Inquadra il QR code per scaricare la cartella colori estesa ZEN. Per maggiori informazioni contattare il customer care a info@steelbox.it. In addition to the 10 standard colors of the ZEN fabric swatch, an extended range of colors is available with a 10% surcharge and a minimum order of 9 panels of the same type. For the color white, there is a 20% surcharge. Scan the QR code to download the extended ZEN color swatch. For more information contact the customer care office export@steelbox.it.



Scarica
i colori tessuti.

Download
the fabric colors.

ENGINEERING

R&D Metalway srl

DESIGNER

Roberto Molteni: Zen, Mikai, Mbox, Kaffeina, Tuck, Hawk, Suite tables&sofa, Jet System, Loop, York

Barbara Pollini: Clara

Officina di Architettura: My Flower

R&D Metalway: Kyoto, Snap, B-Cat, Bin&Umbrella, D-Utility, Mix, Tepee, String, Simplex collection

RENDERING

Matic® Animation

GRAFICA

Damco I Creativi Digitali

STAMPA

Industrie Grafiche Martintype

MARKETING

Forwell Marketing USA

Marketing Department Metalway

Aggiornamento Aprile 2024/Update April 2024

Powered by:



GREEN HEART
GREEN EARTH



ISO 9001

L'azienda si impegna a migliorare i propri prodotti per soddisfare le esigenze di un mercato in continua evoluzione.

A tale scopo ci riserviamo il diritto di apportare le necessarie migliorie e modifiche ai prodotti senza preavviso.

La Direzione

Metalway srl is engaged to improve its products to satisfy the needs of an evolving market.

For this reason all necessary improvements as far as modifications can be carried on without prior notice.

The Management

STEELBOX

STEEL&STYLE

Steelbox
division of Metalway s.r.l
Via dell'Industria 10
64018 Tortoreto
Teramo (Italy)

Tel. +39 0861 1994208
Fax +39 0861 1994382

www.steelbox.it
info@steelbox.it



Witteveen Projectinrichting
Ouderkerk a/d Amstel
Tel: 020 - 496 5030
info@witteveen.nl
www.scheidingswand.net
www.project-inrichting.nl